



POWERPAC -APU

OWNER'S MANUAL AND SERVICE GUIDE

Generator Model _____

Generator Serial # _____

POWER TECHNOLOGY S.E., INC.
634 State Road 44
Leesburg, Florida 34748-8102
Phone (352) 365-2777
Fax (352) 787-5545
www.PowerPacAPU.com

CONTENTS

❖ INTRODUCTION

- Overview
- Requirements for installation
- Parts list
- Tools required

❖ SAFETY ALERTS AND CONSIDERATIONS

- Alerts
- Considerations

❖ INSTALLING THE POWERPAC APU

- Preparation of the PowerPac
- Locating the PowerPac on the frame rail
- Assemble the mounting clips, bolts, and spacers
- Mounting the PowerPac to the frame
- Exhaust pipe

❖ INSTALLING FUEL TUBES AND LINES

- General considerations
- Install tank pickup tube
- Routing and connecting fuel lines to tank

❖ INSTALLING THE BATTERY CABLES

- Cable routing
- Connecting to batteries

❖ INSTALLING THE AC POWER OUTPUT LEADS

- Routing
- Terminal block
- Connections

❖ INSTALLING THE DRIVER CONTROL PANEL

- Selecting location
- Routing wires
- Connections
- Mounting

❖ INSTALLING THE POWER OUTLET BOX

- Selecting location
- Routing wires
- Connections
- Mounting

❖ INSTALLING AIRCONDITIONING AND HEATING SYSTEMS FINISHING THE POWERPAC INSTALLATION

- Check List
- First time Start up

CONTENTS CONTINUED

- ❖ **OPERATION OF POWERPAC APU**
 - Daily checks and maintenance schedule
 - Starting and stopping the PowerPac APU
 - Powering appliance and auxiliary systems

- ❖ **ENGINE SPECIFICATIONS**
 - Model
 - Service parts list

- ❖ **POWERPAC APU MAINTENANCE**
 - Engine maintenance service schedule
 - Engine oil maintenance and specifications
 - Checking engine oil
 - Lubricating oil specifications
 - Lubricating oil capacities
 - Changing lubricating oil and filter
 - Engine coolant maintenance
 - Coolant recommendations
 - Checking coolant level
 - Cooling system purge procedure
 - Checking recovery tank coolant level
 - Cleaning radiator core
 - Air filter maintenance
 - Fuel filter maintenance
 - Fuel system purge procedure
 - Fan belt
 - Generator drive belt

- ❖ **WIRING DIAGRAMS**
 - DC controls and systems
 - AC Generator and systems
 - Circuit breaker locations

- ❖ **TROUBLESHOOTING GUIDES**

- ❖ **SERVICE AND WARRANTY INFORMATION**

INTRODUCTION

You are now the proud owner of a Power Technology SE. Inc. PowerPac APU Idle Reduction System.

The PowerPac is an auxiliary power unit designed to run completely separate from Your main truck engine. It provides 120 volts AC power to the cab of your truck to Run the air-conditioning and heating unit supplied with the unit. The PowerPac also provides AC outlets you can use for other devices such as, television, and coffee makers VCRs, and other appliances that will add comfort to the driver's every day life.

FORWARD

This PowerPac APU System is a product of Power Technology SE. Inc. quality engineering and manufacturing. PowerPac APU systems are made with the finest materials and manufactured under the strictest quality control standards to assure you long satisfactory service.

To obtain the best results from your PowerPac APU system, please read and follow this manual carefully. It will help you become familiar with the operation of the system and contains many helpful hints regarding use and maintenance.

This manual was written to assist with the installation of the PowerPac APU. Although The manual is not specific to any particular vehicle, the information in this manual will Provide the installer with the necessary information to correctly and safely install the unit. A mechanic can easily install the PowerPac APU or someone mechanically inclined. The installer must have a basic understanding of electricity and electrical wiring.

Use this manual as a guide when installing the PowerPac APU system on a vehicle, and then refer to the appropriate operation section for specific instructions. The installation of a PowerPac APU system shall comply with current standards of NFPA 70, NFPA 551, and applicable articles of the National Electric Code. Generator set installations must also comply with state and local requirements.

Follow all instructions in this manual to ensure proper installation and operation. Each generator set features a Kubota or caterpillar diesel engine, rotating-field alternating current generator, and an ECU engine controller. Inside the unit is an on/off switch used to reset the controller or lockout the remote switch to prevent accidental starting while servicing the unit. After the set is attached to the frame of the vehicle, all that is usually required to make it operational are the following.

- Install the fuel pick-up tube assembly
- Route and install fuel lines
- Install and connect remote panel
- Attach Load Leads to vehicle's AC electrical circuit
- Fill radiator with coolant
- Fill crankcase with lubricating oil
- Connect DC battery cables.

Continuing improvements and advancements in product design may cause changes not included in this manual. Please contact Power Technology's Customer Service Department for the latest information regarding your PowerPac APU system.

TO OUR CUSTOMER

Thank you for your purchase of a Power Technology Generator. The information contained in this manual applies only to PowerPac APU Idle Reduction Systems.

In the event you should experience a problem with your system please contact the sales dealer, or Power Technology's Customer Service Department directly at 1-800-760-0027 from 8:00 a.m. to 5:00 p.m. EST Monday through Friday. Please have the system model and serial numbers available when you call, this will help expedite service and parts to you.

POWER TECHNOLOGY S.E., INC.
634 STATE RD. 44
LEESBURG, FL. 34748-8102
(352) 365-2777
FAX (352) 787-5545

CALIFORNIA
Proposition 65
Warning

Diesel Engine Exhaust and some of its constituents are known by the State of California to cause Cancer, Birth Defects and Other Reproductive harm.

REQUIREMENTS FOR INSTALLATION

PARTS LIST

- 1- PowerPac APU Unit
- 1- Loose Parts Bag
 - 1- Driver control box
 - 1- Terminal block
 - 1- Terminal block cover
 - 4- $\frac{3}{4}$ x 7" mounting bolts
 - 8- $\frac{3}{4}$ SAE flat washers
 - 4- $\frac{3}{4}$ Ny-lok nuts
 - 4- Aluminum frame clips
 - 1- Fuel pickup tube
 - 1- Remote panel
 - 1- 1 $\frac{1}{4}$ rubber grommet
 - 4- #4 hose clamps
 - 2- Battery cable ends
 - 2- Heat shrink (for battery cable ends)
 - 8- Sheet metal screws
 - Wire ties



TOOLS REQUIRED

Typical mechanics tools

Drill

1 ¼ Hole saw

Tape measure

Utility knife

Tubing cutter

½” NPT Tap (for fuel pickup tube)

¾” Drill bit or tapered drill bit (for ½” NPT tap)

Heavy grease (to keep metal shavings out of fuel tank)

Liquid thread sealant

Transmission jack, forklift or engine hoist

SAFETY ALERTS AND PRECAUTIONS

A generator set can be potentially dangerous if not properly maintained and operated. The Best safeguard against a dangerous situation is education, good judgment and common sense. For safe trouble free operation of your generator set some general precautions are listed below. Be sure to read, understand and follow these precautions.

SAFETY PRECAUTIONS

- 1) **HOT PIPING**- An engine and exhaust system may get extremely hot while Running. Do not work on a generator set until it has sufficiently cooled.

- 2) **DANGEROUS FUELS**- Use extreme caution when handling, storing and using fuels. All fuels are highly explosive in a vaporous state. Store fuel in a well ventilated area away from spark producing equipment. Keep fuels and all chemicals out of the reach of children. Never add fuel to the tank while the engine is running. Spilled fuel may ignite on contact with hot parts or from ignition spark. Always keep fuel lines and connections tight and in good condition. Don't replace flexible lines with rigid lines. If you notice any fuel leakage, fuel accumulation or electrical sparks, **DO NOT OPERATE THE GENERATOR SET.**

- 3) **EXPLOSIVE BATTERY GASES**- the gases generated by a battery being charged are highly explosive. Do not smoke or permit any flames or sparks to occur near a battery at any time, especially when it is being charged. Avoid contact between terminals with tools to prevent sparks and possible burns. Always remove wristwatch, rings, or other jewelry before handling a battery.
Any compartment containing batteries should be well ventilated to prevent the accumulation of explosive gases. To avoid sparks never disturb the battery charging connections while the battery is being charged. Always turn off the battery charger before disconnecting the terminal clips.

- 4) **ELECTROCUTION**- Failure to install a generator set with an electrical system consistent with governing regulations and standards is **UNLAWFUL** and may cause **ELECTROCUTION** of vehicle occupants. Your generator set must not be used to “Back Feed” by connecting it to a building or outdoor electrical circuit. Back feeding can cause serious injury or death to utility personnel working to repair a power outage and may also seriously injure persons in your vehicle.
Unauthorized connections are unlawful in some states and/or localities. A transfer switch must be installed to prevent interconnection of the generator set power and outside power.

5) **MOVING PARTS**- Keep hands, feet, and clothing away from belts, fan and related pulleys when unit is running. Replace guards, covers and screens before operating the generator set. Serious personal injury may occur from contact with moving parts.

6) **HIGH VOLTAGE**-Remember the function of a generator set is to produce electricity. Wherever electricity is present there is a potential danger of electrocution. Apply the same precautions to the vehicles electrical appliances as you would for any home appliance. Keep away from electrical circuits and wiring while the generator set is running. Have electrical service performed only by qualified electricians. Be sure any unauthorized person; especially children are denied access to the generator set. Keep the compartment door securely latched or locked at all times. Be sure the generator set is properly grounded. Never touch electrical leads or appliances with wet hands, or when standing on wet ground.

7) **EXPLOSION**-Never connect the negative (-) battery cable to the positive (+) connection terminal of the starter solenoid, or test the battery by shorting the terminals together. This could ignite fuel vapors or cause the battery to explode. To disconnect the battery remove the negative battery cable first and reconnect it last. Do not modify the fuel tank or propulsion engine fuel system. Your vehicle must be equipped with a fuel pick-up arrangement as described in the Fuel System section of this manual. Fuel tank and installation must conform to applicable regulations.

8) **HOT COOLANT**- Allow engine to cool and release pressure from the cooling system before opening the radiator pressure cap. To release the pressure, cover the radiator cap with a thick cloth then turn it slowly counterclockwise to the first stop. After the pressure is released and the engine has cooled, remove the cap.

9) **LETHAL EXHAUST GAS**- When installing an exhaust system position the tailpipe end so that the discharged gases may not be drawn into the vehicle interior through windows, doors, air conditioners, etc. The engine powering your generator set discharges deadly carbon monoxide as part of the exhaust gas when running. It is essential that the exhaust system should be leak proof and routinely inspected.

10) **EXCESSIVE NOISE**- never operate the generator set without an adequate muffler or with a faulty exhaust system. Exposure to excessive noise can lead to hearing impairment.

11) **ELECTRICAL SHOCK**-A battery can cause electrical burns and shocks. Use reasonable care when working near the battery to avoid electrical connections by contacting the battery terminals with tools. Remove wristwatch, rings, and all jewelry when working on the generator set.

12) **FLASH FIRE**-A sudden flash fire can cause serious burns. To avoid the possibility of a flash fire do not smoke or permit a flame or spark to occur near the fuel lines, fuel filter, fuel pump or other potential source of spilled fuel or vapors.

13) **FIRE HAZARD**- be careful when parking your vehicle to prevent grass fires from being started by hot exhaust gases or exhaust system. Keep away from hot engine and generator parts to avoid burning yourself. Keep the generator set and compartment clean and free of debris, especially combustible materials. Never store fuel, oil or rags in the generator compartment.

14) **UNIT STARTS WITHOUT NOTICE**- to prevent accidental starting on the units with remote start/stop switch, always disconnect the battery by removing the negative (-) Terminal first and then the positive (+). Always disconnect the unit in this manner before working on the generator or any equipment connected to it.

15) **LOOSE COMPONENTS**- periodically check for and tightens any fasteners that may have become loose from vibration or road shock. Serious damage may possibly occur if components become dislodged or misaligned.

16) **DIESEL ENGINE DAMAGE**- To prevent engine damage from occurring, do not operate the PowerPac APU before completing the installation which includes, adding engine oil, connecting fuel lines, adding coolant, and making sure all electrical connections are made.

INSTALLING THE POWERPAC APU

PREPERATION OF POWERPAC-APU

Pick location for the Powerpac APU. Determine if you will need spacers to clear any bolts or anything that may interfere with installing the Powerpac to the frame rail. If spacers are required, longer mounting bolts may be required for the install.

LOCATE THE POWERPAC-APU ON THE FRAME RAIL

When choosing a location for the PowerPac-APU, several things need to be considered. Vehicles with longer wheel bases should have the PowerPac mounted closer to the sleeper to avoid obstructions in the road such as railroad tracks, speed bumps, curbs or anything else that may come in contact with the PowerPac.

Each truck is different and may require a different installation process. Before beginning the installation, lay out the placement of ALL the components that will be installed. Below are some suggestions on locations to install each component.

The Powerpac APU is designed to be mounted on the existing frame rails of the truck. Mounting the unit on the frame rail with supplied frame clamps is the only acceptable installation. Fabrication of another mounting rail may be unsafe with the given weight and balance of the PowerPac APU.

DO NOT DRILL HOLES, CUT OR WELD ON THE TRACTORS FRAME RAILS!!
These procedures will VOID the tractors OEM Warranty.



Standard PowerPac APU Location: Vehicle passenger side.

This is the standard installation choice because most drivers sleep with their heads on the driver's side. This application is the quietest and will less likely interfere with the drivers sleep. Most trucks mount a step to the catwalk on the driver's side frame rail. The passenger side will usually have fewer obstructions.

Alternate PowerPac APU Location: Vehicle Driver Side.

This is a secondary installation location. It may be necessary to remove steps to catwalk. Not as quiet while the driver is sleeping.



Make certain the Fresh Air Inlet is NOT Obstructed

ASSEMBLE THE MOUNTING CLIPS, BOLTS, SPACERS

The Powerpac APU comes with all the hardware required for the complete installation of the unit. The loose parts bag contains all the necessary bolts, washers, nuts, and frame rail clips. Separate all parts to insure that you have the following: 4- Frame rail clips, 4- $\frac{3}{4}$ " x 7" bolts, 8- $\frac{3}{4}$ " flat washers, 4- $\frac{3}{4}$ " lock nuts.

Once all parts are located, put $\frac{3}{4}$ " washers on all 4 bolts. Set the 4 frame rail clips on the frame roughly where the unit will be installed. Make sure all clips slide easily onto frame rail. If forced damage may occur to the clips.

MOUNTING THE POWERPAC TO THE FRAME

Be sure to use a forklift, transmission jack, overhead lift or other device to lift the PowerPac. Make sure the unit is stable before trying to place it on the frame rail. Remove the front cover. Place the PowerPac on desired location on frame rail. Start with the top and insert the 2 - $\frac{3}{4}$ " x 7" bolts through the holes on the panel closest to the frame rail. Slide the frame clip onto bolt all the way to the frame. Place washer and nut on the bolt and run the nut down until its snug.

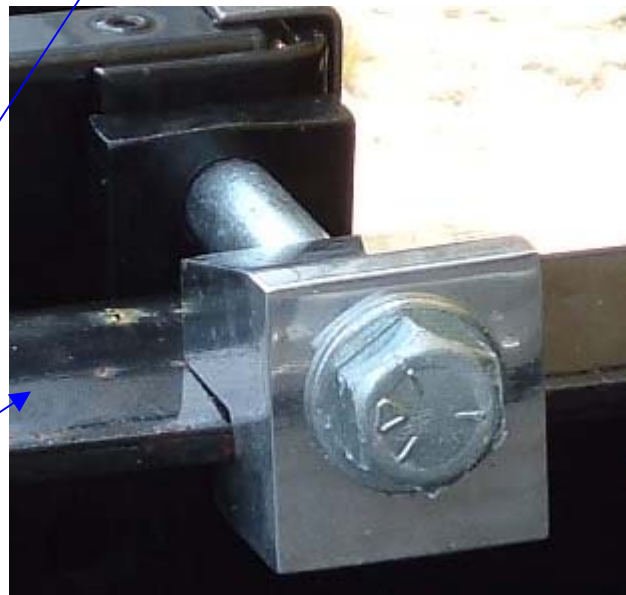
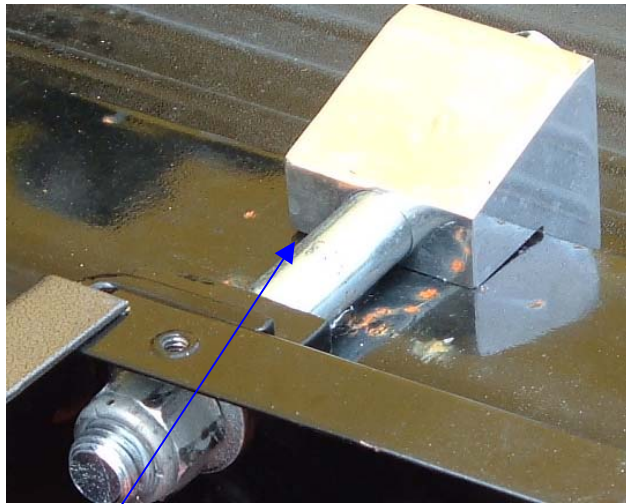

Frame Clamp

Place the 2 - $\frac{3}{4}$ " x 7" bolts through the holes on the underside of the frame rail. Making sure both bottom and top bolts are level, snug up the bottom nuts.



Securely mounted bottom clamp.

Once all 4 nuts are snug, recheck alignment of the bolts. If all 4 bolts are straight, torque nuts to 100 foot lbs. ONLY after all nuts are torqued should you remove the lifting device.

Note: Truck frames may have varying thickness. If the clamp will not fit easily onto the frame, mount direct to the frame or use a weight/load rated mounting bracket system. Damage to the clamp will occur if it forced or hammered onto the frame.

Radiator must have free air flow with no obstructions
Radiator must be protected from grease sling

EXHAUST

Maintain a 3” minimum clearance between any exhaust components and any surrounding combustible materials. If the minimum clearance cannot be met an insulating shield designed for exhaust components must be used.

Extend the exhaust outlet a minimum of 1” past the perimeter of the vehicle. The exhaust system CANNOT be terminated under the vehicle chassis.

Exhaust outlet must be in a position, which prevents exhaust gases from entering the living quarters.

The exhaust system should be routed in a manner, which eliminates the possibility of re-circulation into the APU enclosure.

A skid plate may be installed to protect the APU and exhaust system from road hazards.

Joining the APU exhaust together with the trucks main exhaust may cause irreparable harm please consult with Power Tech prior to making any such connections.

EXHAUST GASES AND FIRE PREVENTION

- Engine exhaust fumes can be very harmful if allowed to Accumulate. Be sure to run the engine in a well-ventilated area Where there are no people or livestock near by.
- The exhaust gas from the muffler is very hot. To prevent a fire, Do not expose dry grass, oil or any other combustible materials To exhaust gas. Keep the engine and mufflers clean all the time.
- To avoid a fire, be alert for leaks of flammables from hoses and lines. Be sure to check for leaks from hoses and pipes, such as Fuel and hydraulic by following the maintenance check list.
- To avoid a fire, do not short across power cables and wires. Check to see that all power cables and wires are in good Condition. Keep all power connections clean. Bare wire or Frayed insulation can cause a dangerous electrical shock and Personal injury.

INSTALLING THE FUEL TUBES AND LINES

The diesel fuel system for the PowerPac APU must be designed to operate independently from the vehicles main engine if both engines are to be operated at the same time. In most installations both engines operate from a common fuel tank with separate pick-up tubes for each engine, not a Tee fitting arrangement. This prevents either or both engines from being starved for fuel. The APU fuel pick-up tube is generally shorter than the vehicles; therefore fuel may not be available to the APU when fuel supply is low. This will prevent the APU from depleting the fuel supply needed by the main drive engine.



NOTE: Using a simple Tee fitting to supply both engines from a common fuel line is not recommended. This practice may possibly cause a fuel starvation situation to either or both engines. Also, if excessive pressure were to build up in the main supply line it could possibly cause a failure of the APU's fuel lines or connectors and a hazardous fuel leak may occur.

Care must be taken when routing the fuel lines from the main tank to the APU. Keep the fuel line as short as possible while maintaining adequate clearance from the exhaust system and moving components. Fuel lines must be run along the frame side rails or under carriage. Never run fuel lines inside the cab. Securely fasten the fuel lines with the hardware that is recommended for the type of fuel line that is used. Allow a minimum of 8 inches of flexible fuel line to make the connection.

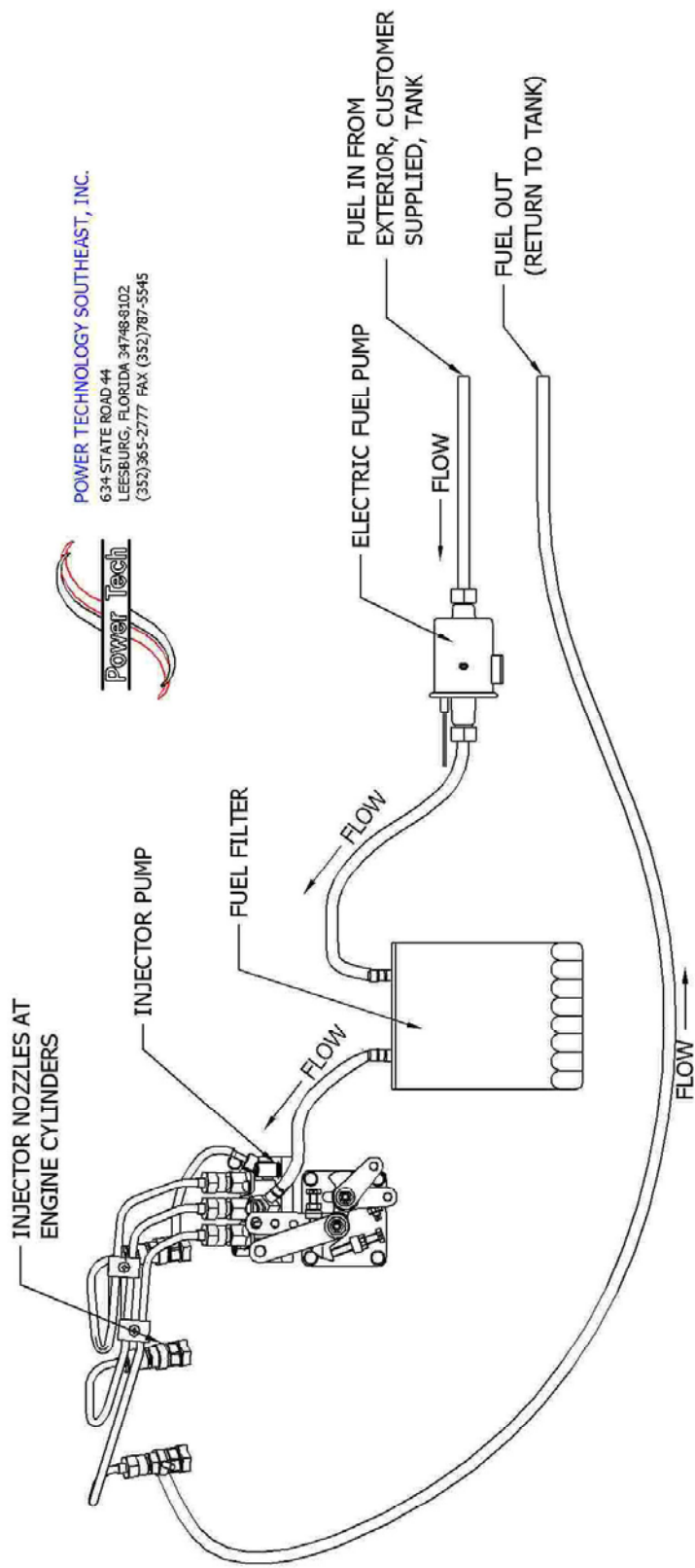

POWER TECHNOLOGY SOUTHEAST, INC.
 634 STATE ROAD 44
 LEESBURG, FLORIDA 34748-8102
 (352)365-2777 FAX (352)787-5545

TYPICAL FUEL LINE DIAGRAM

GENERAL CONSIDERATIONS

Tools Required for Fuel Pick-Up Installation	
Tape Measure	Tubing Cutter
Drill	Heavy Grease
¼" Drill Bit	Thread sealant
Step Reamer Bit or ¾" Drill Bit	

DANGER

Diesel fuel vapors can be very explosive. Use caution when working in or around the area of the fuel tank.

DANGER

Before drilling into a fuel tank it is recommended to drain all fuel from the tank.

DANGER

Be very careful when drilling into a fuel tank. Sparks can be caused by an electric drill or a drill bit that may cause an explosion. (SUGGESTION) Apply a heavy grease around the holes when drilling and tapping into fuel tank to keep metal shavings from getting into fuel tank.

DANGER

DO NOT SMOKE WHILE WORKING NEAR FUEL TANK.

VERY IMPORTANT!! Check fuel tank for baffles and gauge arms before drilling into fuel tank. A fuel pick-up could interfere with the floats and render your fuel gauge inoperable.

INSTALL TANK PICK-UP

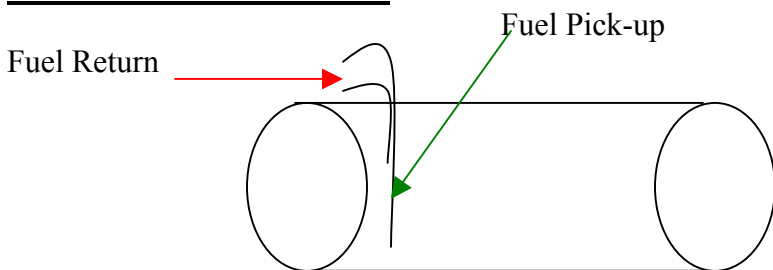

After checking for baffles and fuel gauge linkage, pick a spot on fuel tank for the fuel pick-up tubes (usually top center of tank on end closest to the APU). Apply heavy grease to spot where hole is to be drilled. The grease will help keep metal shavings out of fuel tank. Drill a 1/4" pilot hole. You may want to use several different drill bit sizes to get up to the 3/4" bit required for the fuel pick-up tube. Once you have a 3/4" hole, clean all metal shavings from the hole. Reapply heavy grease and using the 1/2" NPT tap the threads for the fuel pick-up tube. Clean area very thoroughly.

Determine the length needed for the pick-up tube. The recommended length for the pick-up tube is 2" shorter than the depth of the fuel tank. Cut pick-up tube to length needed. Apply thread sealant to the threads of the pick-up tube and screw into fuel tank.

Be sure that pick-up tube is positioned to the center of the vehicle.

ROUTING AND CONNECTING THE FUEL LINES

Care must be taken when routing the fuel lines. You must route lines so they can be strapped securely and in a way that they will not come into contact with anything hot, or any moving components. Suggested routing of fuel lines is as follows: Lines coming out of the PowerPac, Run up into the inside of frame rails. Strap lines either to the backside of the unit, or at first bend in the frame rail. Run along the inside of the frame rail until you reach the fuel tank and the fuel pick-up tubes. Be sure that you have no kinks in the line and that the line is run away from anything abrasive. Strap fuel lines securely with tie straps or clamps.

Once fuel line is secure, you can cut the fuel lines to length using a utility knife. Trim the hose loom back approximately 1 1/2". You will see that you have 2 different size hoses. The 5/16 hose is the supply and the 3/16 hose is the return. Place 2 of the #4 hose clamps (provided) on the end of the 5/16-fuel line and slip onto the larger of the two tubes on the Fuel pick-up tube. Tighten both clamps on the 5/16-fuel line. Once the supply line is secure, do the same with the return line. Make sure all 4 clamps are secure.

INSTALLING THE BATTERY CABLES

IMPORTANT! DO NOT CONNECT BATTERY POSITIVE CABLE UNTIL THE POWERPAC UNIT IS READY TO BE TEST RUN.

Turn the main power switch on the PowerPac APU to the OFF position to ensure the unit will not start prematurely.

Route the positive and negative battery cables from the PowerPac APU to the batteries. Cut battery cables to desired length. Strip the insulation on both cables back about ½". Slide heat shrink over the end of the cables.

Place copper connector

Onto the end of the positive cable and crimp with a crimping tool. Slide heat shrink

Up over the crimped spot on the connector and apply heat-to-heat shrink. Use the same procedure on the negative battery cable.

Be sure the area where the negative cable is to be connected is clean and free of debris that may cause a bad connection.

Leave positive cable loose until the installation is complete.

INSTALLING THE AC POWER OUTPUT LEADS

The AC power output leads (10ga. -4 SO cord) should be routed in a way that they will not come into contact with anything abrasive. Suggested routing of the power cable is, run the loose end of the lead up to the frame rail. Clamp or tie the lead. Run the lead inside the frame rail making sure the lead is secure. Once under the cab route lead to the underside of the bunk area.

Inside the sleeper, lift bunk, determine where the heating and air conditioner unit will be installed (see section on installing heating and air conditioner) locate area to mount the terminal block. Once desired location is determined, use a 1 ¼" hole saw to make a hole for the AC output leads to come into the sleeper area. After hole is drilled, place 1 ¼" grommet in the hole to assure that chaffing doesn't occur. Run AC output leads through this grommet. Secure the terminal block to the floor using the screws provided.

MOTOR LOADS

When figuring generator set capacity requirements for installation involving motor loads, do not overlook the high current demanded by the motor during start-up. The “In-Rush” of starting current may be 2 to 5 times higher than that required when the motor reaches normal operating speed. Reserve capacity must be allowed for in rush demands plus other loads, which could be on the line as the motor starts.

Air conditioning units are the most common type of motor loads for a generator set in a recreational vehicle. The starting characteristics of the different makes of air conditioners vary greatly. For example, a particular 12,000 BTU unit may have lower starting requirements than a 10,000 BTU unit of another make. When only one unit is involved there is usually no starting problem provided of course the lighting and appliance load is not too high when unit is started.

The trend seems to be toward larger capacity air conditioners and the use of more than one unit in larger vehicles. Simultaneously starting two large units can present a problem if the capacity is marginal. Because of the variation in starting characteristics of the different makes of air conditioners, no definite statement can be made in this publication regarding multiple-motor starting capabilities.

Delayed starting or use of “easy starting” devices on air conditioner units should be considered whenever simultaneous starting of more than one motor is involved. The starting and running requirements of some motor loads common to mobile applications are listed in the table below. Use this as a guide when selecting generator set capacity requirements involving motor loads. Also note the Kilowatt De-rating factor for generator set capabilities regarding air conditioners. Capabilities will vary according to “Kilowatt De-rating”.

ELECTRIC MOTOR HORSEPOWER	BASED ON CODE “G” ELECTRIC MOTOR	
	STARTING WATTS	RUNNING WATTS
½	2000	1100
1	3800	1800
2	6000	2800
3	8000	4000
4	11000	5500
5	13000	6500

KILOWATT DE-RATING

All units are rated at 1.0 power factor. The Kilowatts of the generator set will decrease 3.5% per 1,000 feet (305m) above 500 feet (152m) above sea level. De-rate 1% for every 10 °F (5.5°C) above 68°F.

ELECTRICAL LOADS

While the electrical load of the vehicle should have been calculated prior to purchase of the generator set, you may want to recheck the load before installing the set to make sure the capacity is ample to meet the demands without possible overloading.

The lighting load is usually easiest to calculate in most cases, simply add the wattage of each lamp to be operated off the generator set. Note that in many applications, not all of the lights or lamps are in the generator sets AC circuit. Some are DC powered by the 12-volt battery in the vehicle. Make sure the total includes only lights actually on the generator sets AC circuit. The lighting load is usually not too heavy in mobile installations however it must be accurately calculated to prevent overloading. For example, if all lights are on at the same time and the air conditioner or other motor equipment starts up, this may possibly cause an overload situation.

APPLIANCE LOADS

Generator sets in recreational vehicles are often used to supply AC voltage for appliances. With the exception of a resistance-type load such as a water heater, requirements for appliances are usually low. However, such loads must not be overlooked when calculating the total wattage requirements. To avoid an overload situation, reserve capacity should also be calculated for unanticipated appliance loads. The average power requirements for some common electrical appliances are listed below as a guide.

DETERMINING ALTERNATOR LOAD REQUIREMENTS		
CHECK <input type="checkbox"/>	APPLIANCE	WATTS REQUIRED
	VCR	70
	LIGHT BULB	100
	RADIO	100
	TELEVISION	100
	STEREO	100
	FRY PAN	150
	HOME COMPUTER	150
	VACUUM CLEANER	250
	ATTIC FAN 1/4 HP	400
	SUMP PUMP 1/3 HP	500
	REFRIGERATOR	500
	FURNACE FAN 1/3 HP	600
	FREEZER	800
	JET WATER PUMP 3/4 HP	900
	ELECTRIC STOVE ELEMENT	1000
	SUBMERSIBLE WATER PUMP 1 HP	1000
	TOASTER	1000
	COFFEE MAKER	1200
	DISHWASHER	1200
	HAIR DRYER	1200
	MICROWAVE OVEN	1500
	SUBMERSIBLE WATER PUMP 2 HP	1600
	WATER HEATER	3000
	OVEN	4500
	TOTAL WATTS	

EXTENSION CORDS

An extension cord is normally used to provide electrical power from the generator set to a remote location. The extension cord size (AWG#) and length must be adequate to safely maintain the amperage requirements. A proper size extension cord will help minimize the voltage drop between the generator set and remote location.

AMPS	LOAD IN WATTS		CORD LENGTH		
	120 VOLTS	240 VOLTS	AWG#10	AWG#12	AWG#14
5	600	1200	500 FT	300 FT	200 FT
10	1200	2400	250 FT	150 FT	100 FT
20	2400	4800	125 FT	75 FT	50 FT
30	3600	7200	60 FT	35 FT	25 FT
40	4800	9600	30 FT	15 FT	10 FT
50	6000	12000	15 FT	-----	-----

INSTALLING THE DRIVER CONTROL PANEL

SELECTING LOCATION

The Driver control panel consists of a start/stop switch and an hour meter. This control panel is the control for the PowerPac APU.

The control panel should be mounted in the bunk area of the sleeper for easy access while the driver is running the PowerPac. It is typically mounted on the side of a cabinet or the rear wall.

ROUTING WIRES

The remote start wires should be routed with the AC output leads. Make sure the remote leads are secured inside the frame rail. Run the remote start leads through the same hole used for the AC power lead. Secure harness using wire ties. Route harness to location that control panel will be mounted.

WIRE CONNECTIONS (see diagram)

Connect the white/red wire to the top left terminal on the start/stop switch.

Connect the red wire (12v +) to the center left terminal on the start/stop switch.

Connect the orange wire to the bottom right terminal on the start/stop switch.

Connect the green wire to the bottom left terminal on the start/stop switch.

Connect the gray wire to the positive (+) terminal on the hour meter.

Connect the green wire (jumped off the green on start/stop switch) to the Negative (-) terminal on the hour meter.

DRIVER CONTROL PANEL DIAGRAM

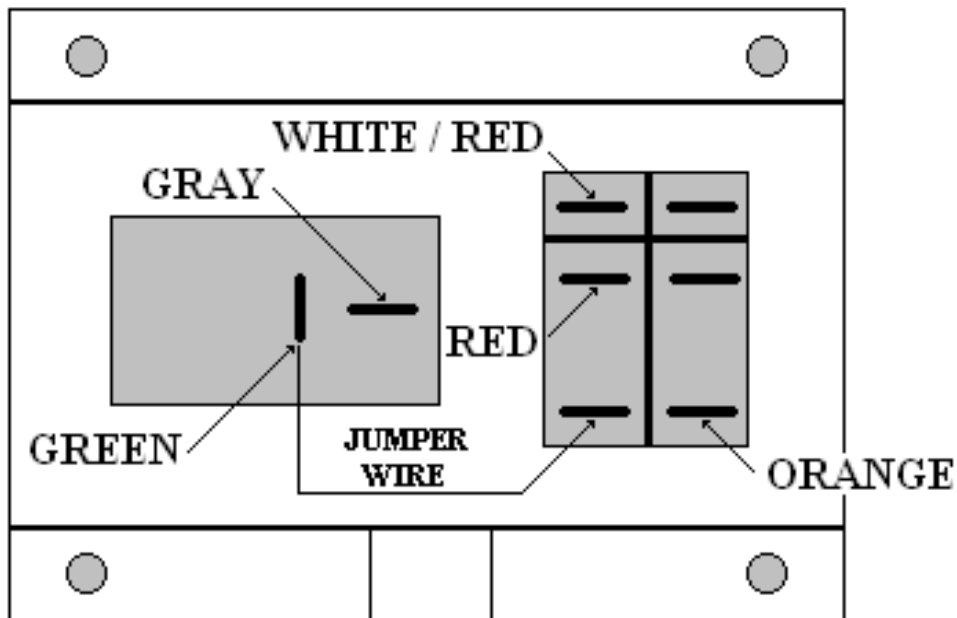

White/Red Wire – sends start/stop signal to the APU

Red Wire- 12v DC constant

Orange Wire- LED signal wire

Gray Wire- 12v Power to hour meter while unit is running

Green Wire- Ground

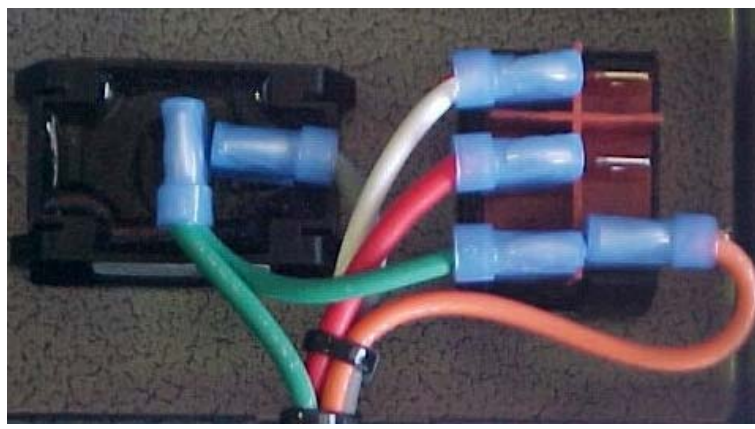

MOUNTING THE CONTROL BOX

Once all connections are made to the start/stop switch and the hour meter, fasten the control box to the desired location with the screws provided.

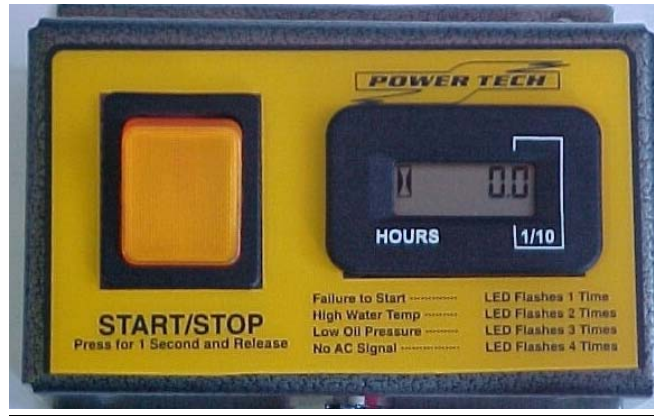

INSTALLING THE POWER OUTLET BOX

SELECT LOCATION

Determine where you want to mount the AC power outlet box. This should be mounted where the driver has easy access to the outlets. Consideration should be taken as to the devices the driver will need AC power for such as, Television, microwave, refrigerator etc. Suggestion, mount the outlet box where most of the appliances a driver may use will be within reach of the outlets without the use of extension chords.

ROUTING WIRES

Once location has been chosen for the power outlet box, run the wires back to the terminal block making sure the wires are secured with wire ties or clamps. These wires should be ran in a way that they will not interfere with anything under the bunk and away from anything abrasive.

CONNECTIONS

Once wires are secured connections for the AC power can be made. Connect the positive (+) wire to the black wire on the terminal block. Connect the white wire to the white wire on the terminal block and the green wire to the ground (green) wire on the terminal block.

AC POWER TERMINAL BLOCK DIAGRAM

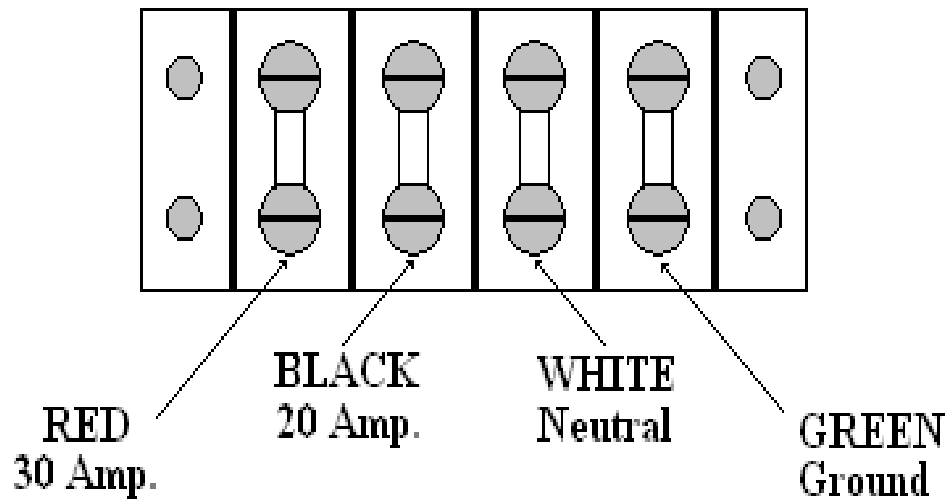

Red Wire- 30 Amp circuit for Heating / Air conditioner unit.
Black Wire- 20 Amp circuit for Driver's comfort appliances.
White Wire- AC Neutral
Green Wire- Ground

MOUNTING THE POWER OUTLET BOX

After all connections are made, fasten the power outlet box to desired location with the screws that are provided.

INSTALLING THE AIR CONDITIONING AND HEATING SYSTEM

The PowerPac APU system uses a heating and air conditioning unit supplied by Dometic called “TUNDRA”. A complete installation manual is included with the Tundra unit.

Use this manual to successfully install the heating and air conditioner unit.

When making electrical connections for the heating and air conditioning system, be sure to use the RED wire on the terminal block to power the system. The white and green wires will be connected to the same terminals as the power outlet box white and green wires. It is **VERY IMPORTANT** these connections be made this way to prevent overload to a single circuit.

Once connections are made, install the terminal block cover using the screws provided.

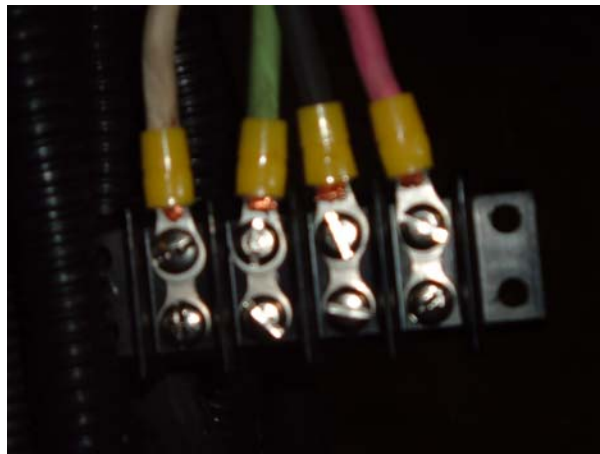

FINISHING THE POWERPAC INSTALLATION

CHECK LIST

- ❑ Unit is securely mounted to vehicle
- ❑ All fasteners are torqued to specification
- ❑ Fuel lines are properly secured
- ❑ Battery cables are properly secured
- ❑ Power cable is properly secured
- ❑ Cables and fuel lines are away from moving components
- ❑ Cables and fuel lines are away from exhaust
- ❑ Fuel lines are double clamped and all clamps are tight
- ❑ All AC power connections are complete and tight
- ❑ Driver control panel installation is complete
- ❑ Power outlet box installation is complete
- ❑ Heating and Air conditioner installation is complete

FIRST TIME START UP

Before starting the PowerPac APU:

- ❖ Check oil level in the PowerPac
- ❖ Check coolant level
- ❖ Make sure all electrical connections are complete
- ❖ Make sure fuel lines are connected and contain no kinks
- ❖ Make sure driver control panel Start/stop switch is in OFF position
- ❖ Make sure the main power switch in the control box on the APU is in OFF position
- ❖ Connect the positive cable from the PowerPac to the truck battery

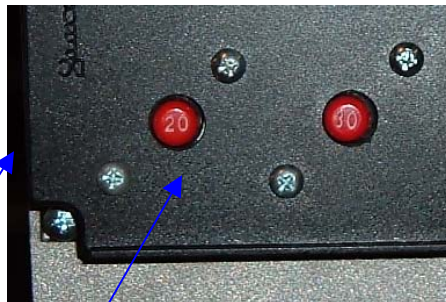

20 AMP and 30 Amp Circuit Breakers

Now that the positive battery cable is connected to the truck batteries, turn the main power switch located in the control box inside the PowerPac APU to the ON position.

Inside the sleeper area of the truck, turn the driver's control switch to the ON position.

Warning: Be careful of moving parts!!!

The Powerpac should start up. It will be necessary to purge all the air from the fuel lines, so the unit may run rough or shutdown. If the PowerPac shuts down, you will have to reset the ECU by turning the main power switch inside the APU control box off, then back on. Start the unit again. This procedure may need to be done a few times before the engine runs smoothly.

Once engine is running smooth, check the PowerPac for coolant, fuel, oil and exhaust leaks. Place the PowerPac cover on the unit. **IMPORTANT!!** Do NOT run the unit without the front cover for longer than 5 minutes. The front cover is necessary for the cooling system of the PowerPac. Damage may occur if the unit is allowed to run longer than 5 minutes.

Place front cover on PowerPac APU. With a multimeter, check the voltage at the AC power outlet box in the sleeper of the truck. Voltage should read 120 to 123 volts AC.

Check the DC power at the batteries to ensure the PowerPac is charging the truck batteries.

Allow PowerPac to run for 30 minutes and check again for coolant, oil, fuel and exhaust leaks.

After checking the PowerPac over thoroughly, test the heating and air conditioning unit to ensure that it's working properly. Allow the PowerPac to run for 30 minutes with the heating and air conditioning unit in operation. This will put a load on the PowerPac and allow the unit to build up more heat. At the end of the 30-minute time period, turn the heating and air conditioning unit off and flip the driver control panel switch for the PowerPac to the Off Position. Remove the front cover and check for coolant leaks. If no leaks are visible, replace front cover.



Congratulations, The installation is complete.

OPERATION OF THE POWERPAC UNIT

Engine Break-in Period

During the engine break-in period, observe the following recommendations:

1. Change the engine oil and oil filter cartridge after the first 50 hours of operation. (See “ENGINE OIL” in ENGINE MAINTENANCE SERVICE SCHEDULE)
2. In ambient temperature above 32°F (0°C) approximately 3-5 minutes without a Load is sufficient for engine warm up. Allow additional warm up time when Temperatures are below 32°F (0°C) before placing an operating load on the Engine.

Daily Checks and Maintenance Schedule

Daily Check

To prevent future engine problems from occurring, it is important to know and keep track of the engines condition. Below are items to be inspected and checked on a daily basis.

CAUTION: To avoid personal injury:

- Be sure all safety shields and guards are attached to the engine when operating.
- To prevent a fire hazard, keep foreign materials, fuel and oil away from the battery, wiring, muffler and engine. Check and clear them daily. Be aware of the muffler and exhaust gas heat underneath the engine compartment, this heat may ignite grass or other flammable materials.
- Follow all safety precautions as outlined in the “SAFE OPERATION” section.

1. For accurate readings the engine should be on level ground when checking engine fluids.

2. Check fluids before starting the engine (cold engine)

- Lubrication System: Check oil level
Check for engine oil leaks.
- Cooling System: Check coolant level and condition
Check for coolant leaks
Check for proper installation of the radiator cap
- Fuel System: Check for sufficient quantity of fuel
Check for fuel leaks

3. Check engine after starting. (Warm engine)

- Proper operation: Check for easy engine start
Check for fluid leaks
Check for abnormal engine noises
Check for abnormal exhaust gases

Starting and Stopping the PowerPac APU

CHECK BEFORE OPERATING THE ENGINE

- If the engine is malfunctioning DO NOT operate until repairs are made.
- Be sure all guards and shields are in place before operating the engine. Replace any that are damaged or missing.
- Check to see that the area around the engine is clear of foreign objects before starting.
- Always keep the engine at least 3 feet (1 meter) away from buildings or other facilities.
- DO NOT allow children or livestock to approach the machine while in operation.
- DO NOT start the engine by shorting across starter terminals.

Engine starting controls

- 1) PowerPac Main switch (located inside the internal control box on the APU) must be in ON position.
- 2) Turn the driver control panel switch to the ON position.
- 3) Glow plugs will preheat for 8 seconds. LED light flashes slowly.
- 4) Preheating will cease during engine cranking cycle. LED light continues flashing.
- 5) Engine begins an 8 second crank cycle, After 4 seconds of cranking the PT ECU-63 will check for an AC signal from the generator. If an AC signal is verified the engine will start and the LED will remain ON during the normal run operation. If the AC signal is not verified the PT ECU-63 will terminate the cranking cycle and LED light will flash a fault code.
- 6) Starter disengages immediately after engine run is verified.
- 7) PT ECU-63 deactivates the low Oil Pressure and high Water Temperature switches for 6 seconds, this will assure oil pressure build up time. If oil pressure does not build up the engine will immediately shut down and go into a fault mode. Likewise for a high temperature situation.
- 8) If engine will not start on the first attempt the PT ECU-63 will initiate the start cycle 2 more times before going into fault mode. Glow plugs will preheat for 8 seconds per attempt. Engine will crank for 8 seconds per attempt.
- 9) To shut down the engine under normal operations, flip the driver control box switch to the OFF position.
- 10) If a fault occurs during the normal operation of the PowerPac the LED on the driver control box will flash a code. This code will help troubleshoot the problem. Count the flashes to determine the problem and refer to the service manual for corrective procedures. The fault codes are as follows

LED Flashes 1 Time: Failure to Start

LED Flashes 2 Times: High Water Temperature

LED Flashes 3 Times: Low oil Pressure

LED Flashes 4 Times: No AC signal

- 11) If a fault occurs during the operation of the PowerPac, correct the problem and then reset the PT ECU-63. To do this the main power switch for the APU (located inside the internal control box on the APU) must be turned off then back on. This will clear fault codes. **IMPORTANT** make sure driver control panel switch is in the OFF position before attempting to clear fault codes. If driver control panel switch is in ON position when resetting the ECU, the unit could start and cause injury.

Stopping the Engine

It is recommended to disconnect or reduce the power load by turning off appliances before shutting down the engine. Then follow the steps outlined above for normal shutdown.

Powering Appliances and Auxiliary Systems

Once the PowerPac APU is running, you will have AC power through the power outlet box. Plug devices such as television, DVD player, cell phone charger etc. directly into outlet.

For heating and air conditioning system please refer to the user's guide supplied with the heating and air conditioning system.

IMPORTANT: Damage to starter motor, starter solenoid, run solenoid or any generator component due to excessive or prolonged starting attempts attributed to an external low battery control monitoring or auto start system not approved by Power Technology SE Inc. will not be covered by the Power Technology SE inc. limited warranty.

ENGINE SPECIFICATIONS

<u>MODEL</u>	<u>KUBOTA Z482</u>	<u>CATERPILLAR CO.5</u>
Continuous Output	8.5 HP @ 2800 rpm	8.5 HP @ 2800 rpm
Fuel and type	Diesel, 4 cycle	Diesel, 4 cycle
Cylinder Arrangement	2 In-line	2 In-line
Bore and Stroke	2.64 x 2.69 (67 x 68mm)	
Cubic Capacity	29.23in ³ (.479L)	
Compression Ratio	2:1	2:1
Engine oil Capacity	3.7 quarts	3.7 quarts
Coolant System Capacity		

SERVICE PARTS

Power Tech Part

Oil Filter	01F0091	01FOCAT
Fuel Filter	08FFR12T	08FFR12T
Air Filter	04FA11180	04FA2SE1
Belts:		
Generator Drive Belt	03BELT5KW	03BELT5KW
Fan Belt	17594-97011	

PT-ECU-63 ENGINE CONTROL MODULE

- 1) Generator Main Switch must be in the ON position.
- 2) Hold Start/Stop Switch for 1 second and release.
- 3) Glow Plugs will preheat for 8 seconds. LED flashes slowly.
- 4) Preheating will cease during engine cranking cycle. LED continues flashing.
- 5) Engine begins an 8 seconds crank cycle, After 4 seconds of cranking the PT-ECU-63 will check for an AC signal from the generator. If an AC signal is verified the engine will start and the LED will remain ON during the normal run operation. If the AC signal is not verified the PT-ECU-63 will terminate the cranking cycle and LED will flash a fault code.
- 6) Starter disengages immediately after engine run is verified.
- 7) PT-ECU-63 deactivates the Low Oil Pressure and High Water Temperature Switches for 6 seconds, this will assure oil pressure build-up time. If oil pressure does not build-up the engine will immediately shut down and go into a fault mode. Likewise for a high temperature situation.
- 8) If engine will not start on the first attempt the PT-ECU-63 will initiate the start cycle 2 more times before going into a fault mode. Glow Plugs will preheat for 8 seconds per attempt. Engine will crank for 8 seconds per attempt.
- 9) To shut down the engine under normal operations, hold the Start/Stop Switch for 1 second and release.
- 10) If a fault occurs turn Generator Main Switch OFF and then ON to reset PT-ECU-63.

Fault Codes:

Failure to start	LED Flashes
Engine High Water Temperature	1
Low Oil Pressure	2
No AC Signal	3
Low Coolant Level (Option)	4
	5

NOTE: The PT-ECU-63 is designed to operate on 12V DC power. In a low battery situation the PT-ECU-63 may not initiate the normal cranking cycle. To start the generator you can press and hold the Start/Stop Switch for approximately 10 seconds or until the engine starts. Once the engine starts the PT-ECU-63 will resume normal operations. If this situation reoccurs, charge or replace the battery.

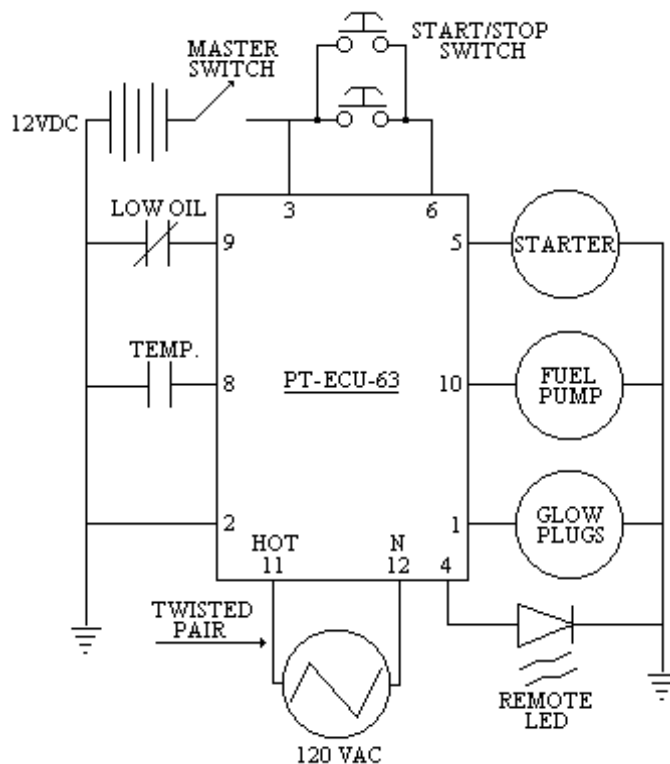

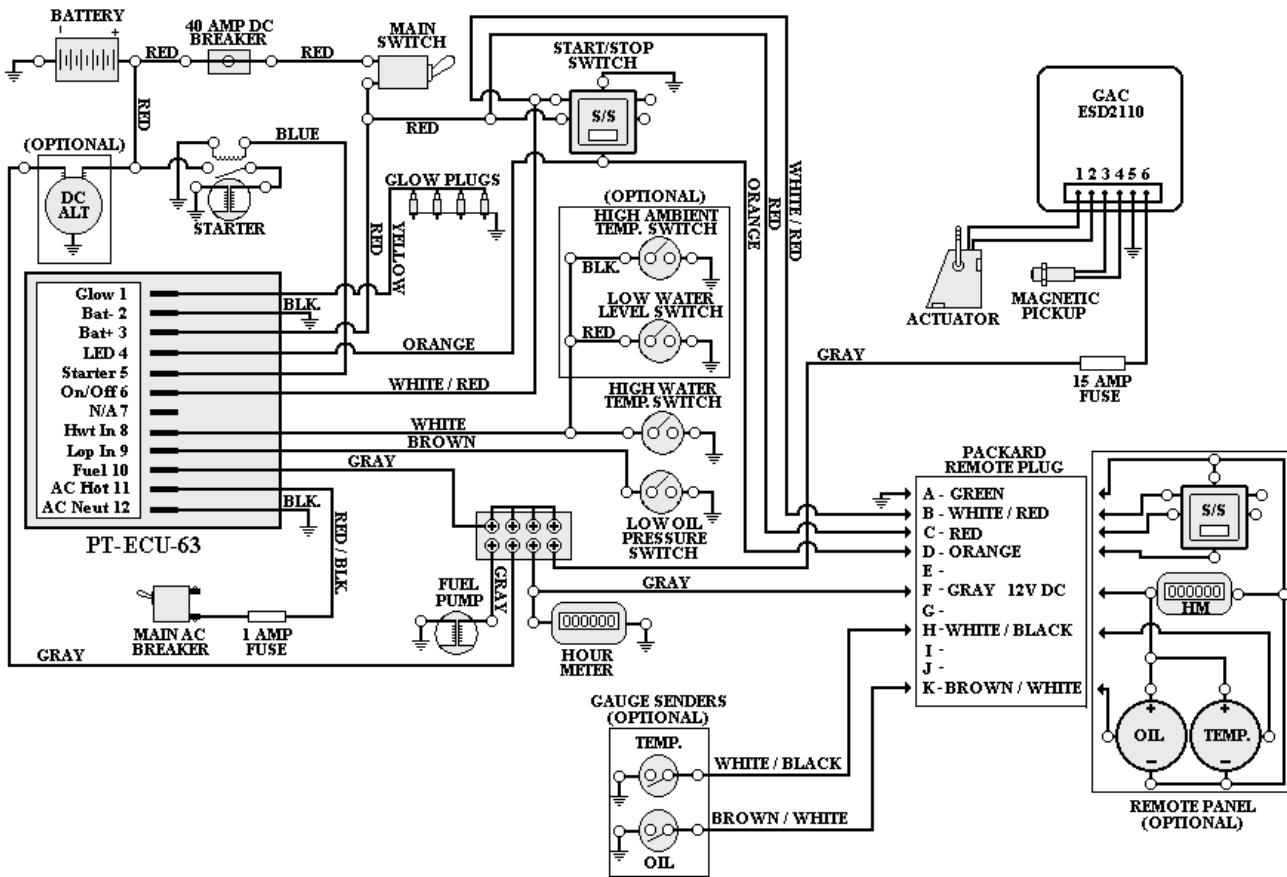
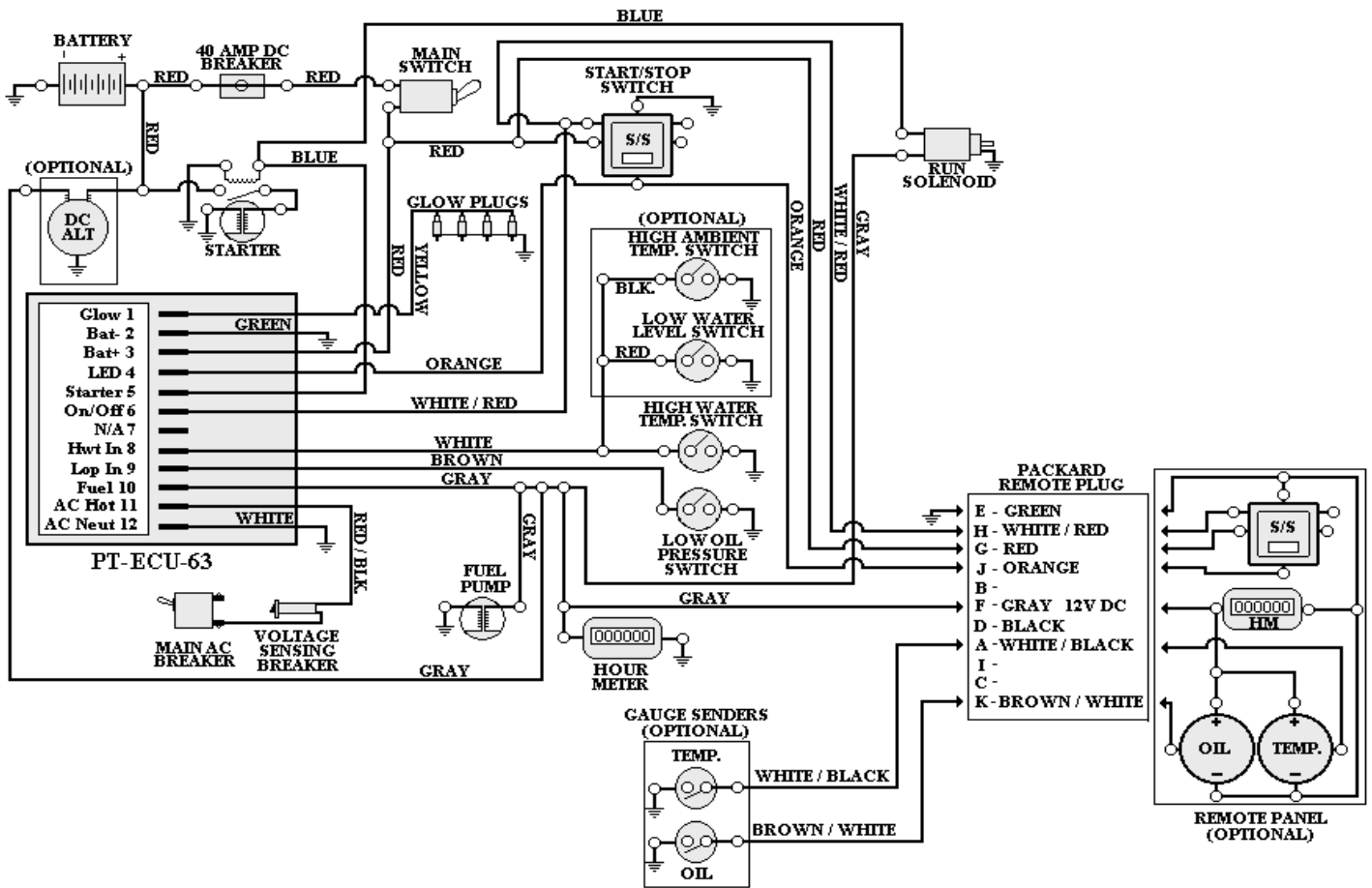

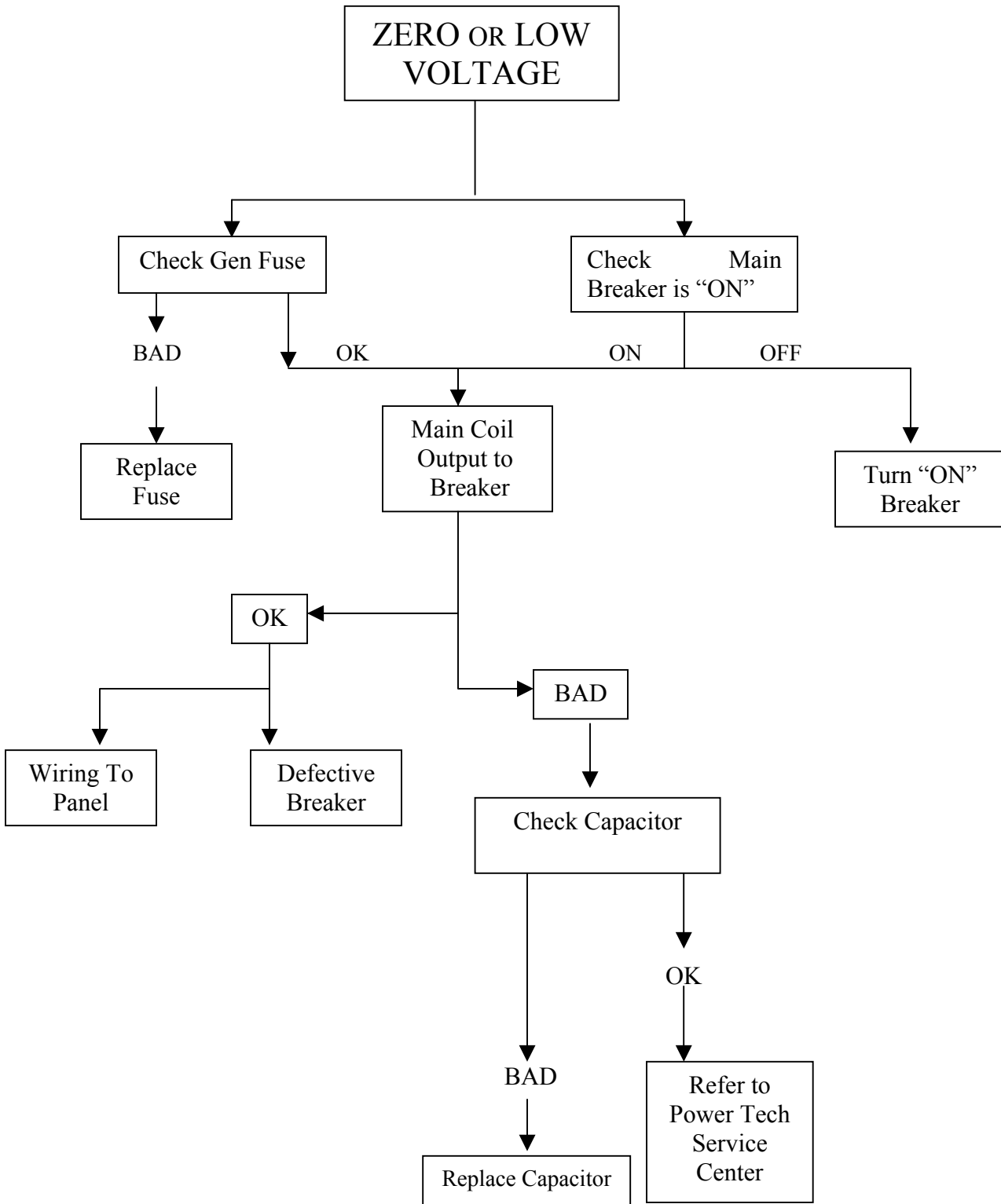

ENGINE WILL NOT START

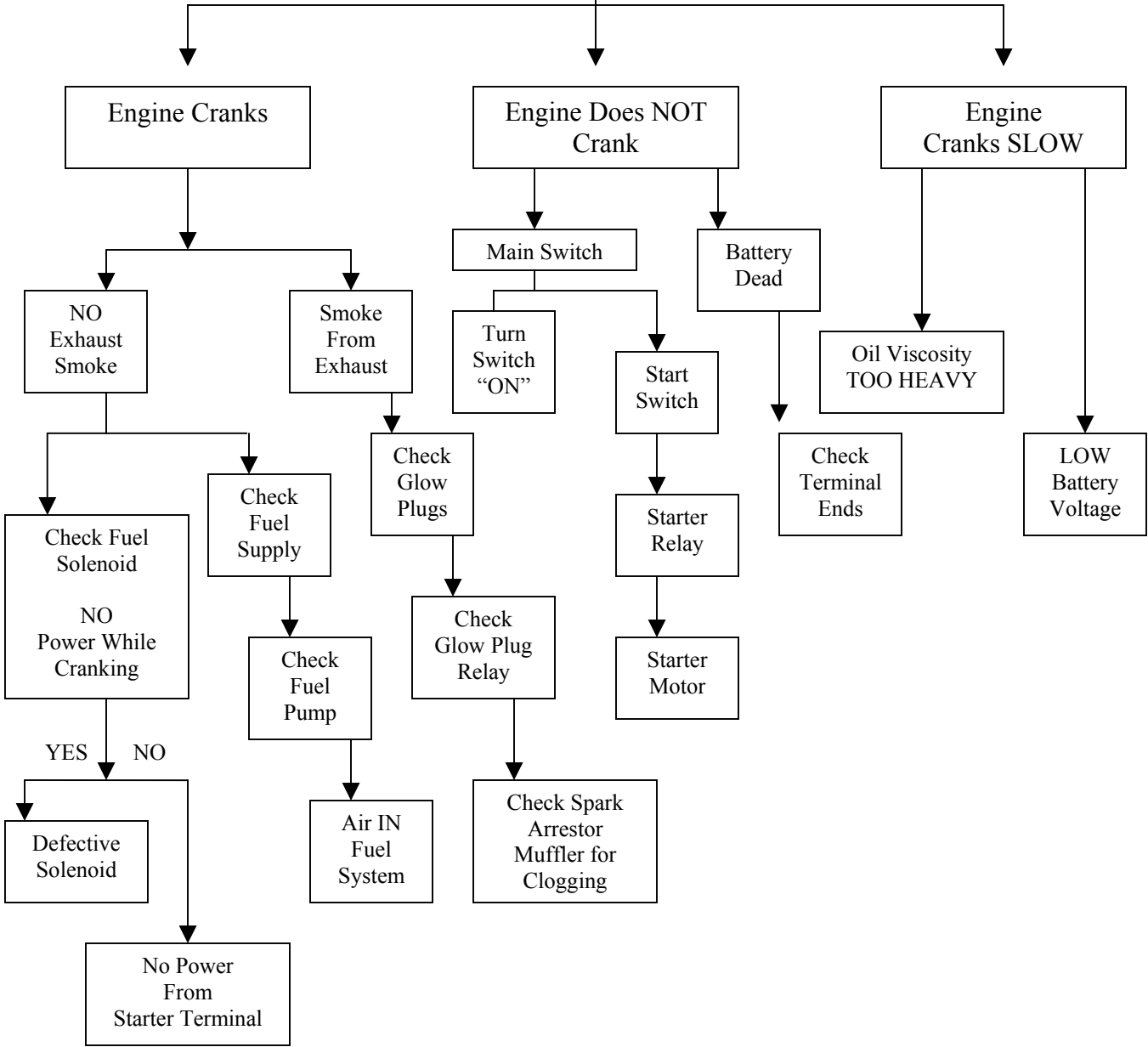

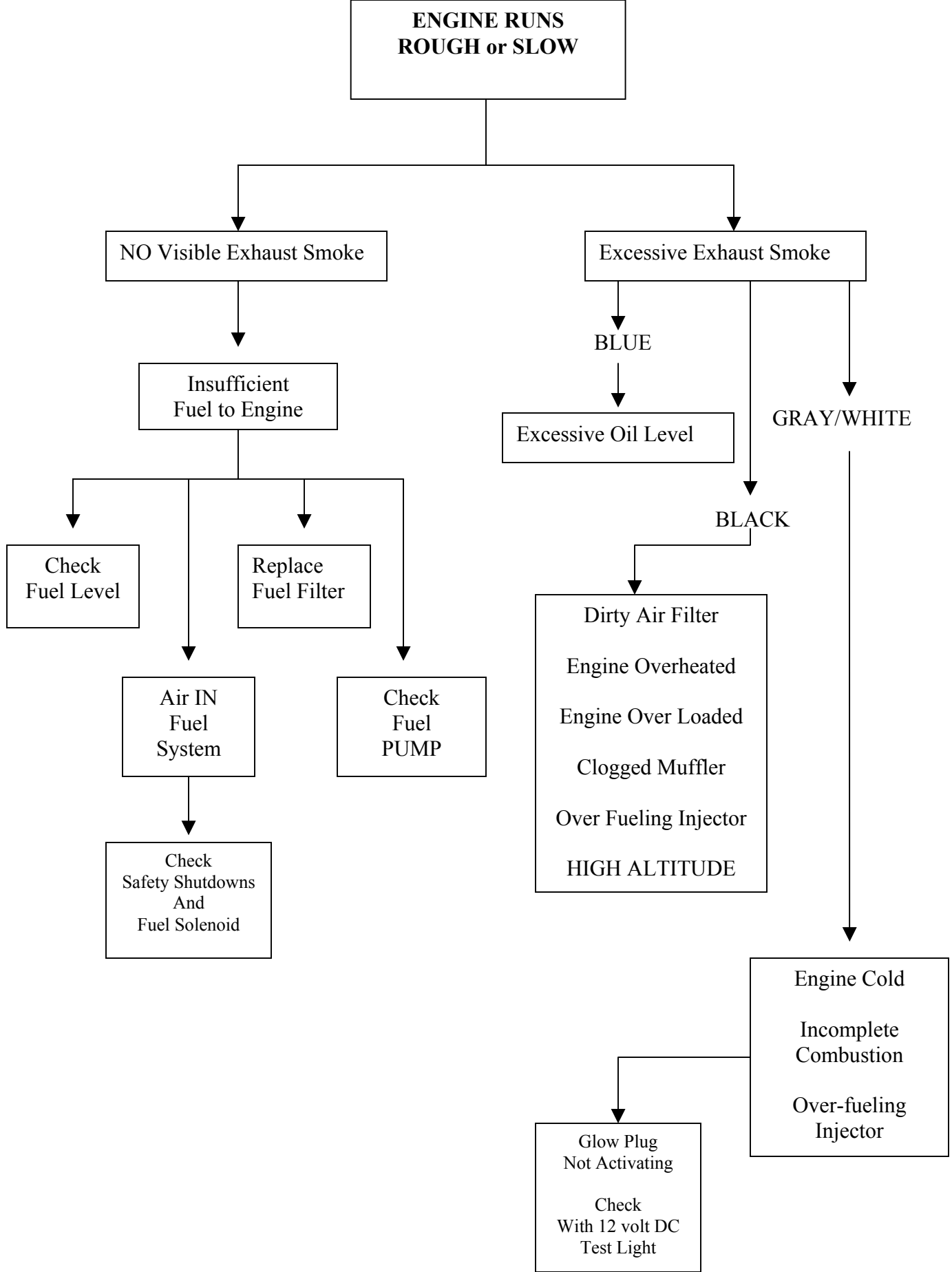

CHECKING ENGINE OIL LEVEL

**V-1903-BG, V-2003-T, V-2203-BG ENGINE
REFILL CAPACITIES**

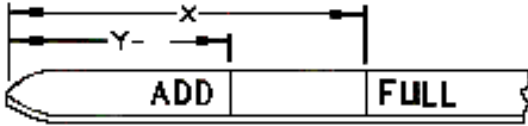

Crankcase Oil Sump and Filter 8.5 Qts. (8.04L)

(Y) “ADD” mark. (X) “FULL” mark.

1. Maintain the engine oil level between “ADD” mark and “FULL” mark on oil level gauge. Do not fill crankcase above “FULL” mark.

2. Remove the oil filler cap and add oil, if necessary. Clean the oil filler cap. Install the oil filler cap.

The refill capacities for the engine crankcase Reflect the approximate capacity of the crankcase or sump plus a standard oil filter. Auxiliary oil filter systems will require additional oil.

**LUBRICATING OIL VISCOSITY
RECOMMENDATIONS**

The minimum ambient temperature during cold engine start-up and the maximum ambient temperature during engine operation determine the proper SAE viscosity grade of oil.

Refer to the Engine Oil Viscosity Table below (Minimum Temperature) in order to determine the required oil viscosity for starting an engine in cold conditions.

Refer to the Engine Oil Viscosity Table below (Maximum Temperature) in order to select the oil viscosity for engine operation at the highest ambient temperature that is anticipated.

**LUBRICATING OIL
SPECIFICATION**

Use only good quality lubricating oil, which meets or exceeds of the following Specification

API-CD
or
Higher

Ambient Temperature	Oil Viscosity
Above 25°C (77°F)	SAE 10W-30 SAE 30 or SAE 10W-40
0 to 25°C (32° to 77°F)	SAE 10W-30 SAE 20 or SAE10W-40
Below 0°C (32°F)	SAE 10W-30 SAE 10W or SAE 10W-40

ENGINE COOLANT MAINTENANCE

COOLANT RECOMMENDATIONS

For optimum performance, Power Technology recommends a 1:1 mixture of water / glycol.

NOTE: Use a mixture that will provide protection against the lowest ambient temperature.

NOTE: 100 percent pure glycol will freeze at a temperature of -23°C (-9°F).

Most conventional heavy-duty coolant / antifreezes use Ethylene Glycol. Propylene Glycol may also be used in a 1:1 mixture with water. Ethylene and Propylene Glycol provide similar protection against freezing and boiling. See the tables below.

ETHYLENE GLYCOL

	Freeze	Boil
<u>Concentration</u>	<u>Protection</u>	
<u>Protection</u>		
50 Percent	-36°C (-33°F)	106°C (223°F)
60 Percent	-51°C (-60°F)	111°C (232°F)

PROPYLENE GLYCOL

	Freeze	Boil
<u>Concentration</u>	<u>Protection</u>	<u>Protection</u>
50 Percent	-29°C (-20°F)	106°C (223°F)

NOTE: Do not use Propylene Glycol in concentrations that exceed 50 percent glycol because of Propylene Glycol's reduced heat transfer capability. Use Ethylene Glycol in conditions that require additional protection against boiling or freezing.

COOLANT SERVICE LIFE

<u>Coolant Type</u>	<u>Service Life</u>
Commercial Heavy-Duty Coolant/Antifreeze that Meets "ASTM D5345"	3000 Service Hours or Two Years

Commercial Heavy-Duty Coolant/Antifreeze that Meets "ASTM D4985"	3000 Service Hours or One Year
---	--

NOTE: Do not use a commercial coolant/antifreeze that only meets the ASTM D3306 or D4656 specification. This type of coolant/antifreeze is made for light duty automotive applications.

CHECKING RESERVOIR TANK COOLANT LEVEL

(At a Minimum of 25 Hours of Operation) Ensure that the coolant level of the radiator reservoir tank is between the upper limit (FULL) and the lower limit (LOW) on the side of the reservoir tank.

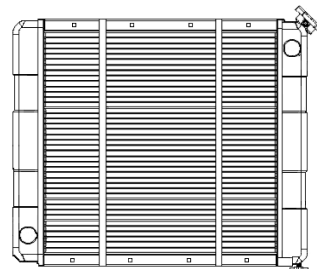

CLEANING RADIATOR CORE

Visually inspect the core for any obstructions such as dirt or debris. Use running water to clean particles from between fins.

IMPORTANT: Never use hard objects to clean radiator core, damage to core could result.



Limited Warranty on Power Tech Generators

Power Technology Southeast, Inc. warrants to you, the original purchaser, that each product of our manufacture is free from defects in materials, and workmanship. That each generator will deliver its rated output as indicated on The Power Technology Nameplate, if properly installed, serviced, and operated under normal conditions in accordance with Power Technology's instructions.

THE WARRANTY COVERAGE TERMS:

2 years from date of purchase, or 3000 hours whichever comes first, or 36 months from the date of manufacture. Parts, and labor, including diagnostic labor, removal, and reinstallation are covered for the first 12 months from date in service or 1000 hours whichever comes first.

Parts and labor are covered only on the following generator and engine parts for 2 years or 3000 hours whichever comes first. Generator Parts: Main Rotor and Main Stator. Engine Parts: Cylinder Block, cylinder head, crankshaft, camshaft, cylinder head gears, connecting rods, flywheel and flywheel housing, intake and exhaust manifold (only if flexible connection is used).

- 3) Stand-by Units are covered for a period of 1 year from date of installation, or 1000 hours, or 24 months from the date of manufacture whichever comes first.
- 4) Replacement Parts are warranted: 30 days. (Excluding the following: voltage regulators, fuses, controllers, capacitors, brushes, and switches)

WHAT POWER TECHNOLOGY WILL DO:

Power Tech will at our option, repair or replace any part covered by this warranty which becomes defective, malfunctions or otherwise fails to conform to this warranty under normal use and service during the term of this warranty.

WHAT YOU MUST DO TO OBTAIN WARRANTY SERVICE:

In order to obtain warranty repairs you must deliver the product, together with proof of purchase to an authorized Power Tech service facility. In the case of repairs pertaining to the engine only, you must use an authorized dealer or distributor of that make of engine, to be covered under their warranty. Engines used in the manufacture of Power Tech products are warranted solely by the engine manufacturer.

PRIOR APPROVAL IS REQUIRED FOR ANY WARRANTY SERVICE

Failure to obtain authorization prior to the repair being performed will result in the claim being denied.

All claims must be submitted within 30 days of the repair. Along with the following: a copy of the original repair order, Power Tech authorization number, Power Tech serial number, and operation hours shown on the genset mounted hour meter.

THIS WARRANTY DOES NOT COVER THE FOLLOWING:

A. Normal wear items, including but not limited to: turbo-chargers, fuel injector (s), starter, alternator, and electronic components, as well as normal engine and/or generator wear. **A1.** Travel time and fuel charges to and from the repair facility or travel time and fuel charges for mobile service. (Except stationary units with a maximum of 2-hours travel time.) **B.** Defects, malfunctions or failure resulting from accidents, abuse, misuse, improper servicing, improper installation, improper storage, and lack of performance of required maintenance service. **C.** Products which have been subjected to alteration, modification, neglect or unauthorized repairs. **D.** Troubleshooting, routine service, tune-ups, replacement of filters, belts, coolant, lubricants, hoses, clamps, exhaust system components, fuel system components, gaskets and/or seals. **E.** Electrical items damaged by welding or jump-starting. **F.** Damage caused by water ingestion or electrolysis. **G.** Damage caused by ingestion of substances other than clean filtered air, fuel, or intake water. **H.** Damage caused by faulty repairs performed by a repair facility not authorized in writing by Power Tech. **I.** Damage caused by operation with improper fuel or at speeds, loads, conditions, modifications, or installation contrary to published specifications or recommendations. **J.** Original installation charges and startup costs. **K.** Removal and re-installation charges of more than 1-hour labor for outside units, 2-hours for compartment mounted units, and 3-hours for below deck marine units. Customer is responsible for additional labor/charges due to difficult access, removal or installation. **L.** Starting batteries and labor or charges related to battery service. **M.** Loss of revenue or the rental of equipment due to down time. **N.** Generator repairs made within the warranty period other than by an authorized Power Tech service dealer without prior written approval from Power Tech warranty department. **O.** Damage caused by negligent maintenance such as but not limited to: Failure to provide the specified type and quantity of lubricating oil, cooling air flow, and proper coolant mixture and level. Failure to provide adequate air intake/or maintenance of the air intake system. Failure to provide scheduled maintenance as prescribed in supplied manuals. **P.** Engine fluids such as fuel, oil or coolant/antifreeze. **Q.** Shop supplies such as adhesives, cleaning agents, rags, paint, or other miscellaneous supplies. **R.** Use of other than factory supplied or approved repair parts or procedures. Replacement of a failed Power Tech component with a non-Power Tech component voids the Power Tech warranty on that component and any and all failures related to that component. **S.** Fuel injection pumps repaired by anyone other than the factory authorized dealer or distributor of that engine. **T.** Expenses incurred investigating performance complaints unless defective Power Tech materials or workmanship are discovered. **U.** Generator sets used in rental applications. **V.** Cleaning, service, or repair of generator sets that have not been kept free of dirt, debris, or other items that prevent the unit from being able to operate properly. **W.** Any generator set not application approved. **X.** Loss of excitation due to prolonged storage. **Y.** Any damage attributed to low battery monitoring or automatic generator starting systems. **Z.** Optional accessories are warranted solely by the manufacturer of that item including but not limited to the following item: Block heaters, oil pan heaters, electric cooling fans, air-bag isolators, compartment heaters, fuel tanks, trailers, battery chargers, battery monitors.

To obtain warranty service: For your nearest Power Tech authorized service center, on the World Wide Web at: http://www.powertech-gen.com/parts_service.php

Call 1-352-365-2777 or write to Power Tech Warranty Department, P.O. Box 490133 Leesburg, FL 34749 USA.

Power Tech must be notified in writing within five (5) business days of any product failure.

General Conditions:

This Warranty is the sole property of the original owner /user.

A transfer of ownership shall terminate this Warranty.

This Warranty is only valid within the contiguous United States and Canada.

Warranty coverage is available outside the U.S. and Canada; please speak to a factory representative for those details.

This Warranty does not cover any products or parts not purchased from Power Technology.

Power Technology reserves the right to make design improvements and model changes without any obligation to change units or parts previously manufactured.

Warranty registration card must be completed and mailed to Power Tech at the above address to validate the Warranty.

This is the only express warranty on Power Tech products

No person, agent, or dealer is authorized to give any Warranties on behalf of Power Technology Southeast, Inc., and not to assume for Power Technology Southeast, Inc. any other liability in connection with any of its products unless made in writing and signed by an officer of Power Technology Southeast, Inc.

LIMITATIONS ON OUR RESPONSIBILITY WITH RESPECT TO PRODUCTS PURCHASED AND USED FOR PERSONAL, FAMILY OR HOUSEHOLD USE:

Our responsibility is to repair or replace defective parts as stated above. We will not be responsible for any other expenses, losses or inconvenience which you may Sustain as a result of the purchase, use, malfunction or defective condition of our products. **ANY IMPLIED WARRANTIES, INCLUDING WARRANTIES OF MERCHANTABILITY OR FITNESS FOR A PARTICULAR PURPOSE SHALL BE LIMITED IN DURATION TO THE PERIOD SET FORTH ABOVE.**

Some states do not allow limitations on how long an implied Warranty lasts or the exclusion or limitation of incidental or consequential damages, so the above

Limitations or exclusions may not apply to you. This Warranty gives you specific legal rights and you may have other rights which vary from state to state.

This Warranty is in lieu of all other Warranties, expressed or implied and of any other obligations or liability on our part.

Our responsibility for any and all losses and **IN NO EVENT WILL WE BE LIABLE FOR LOSS OF USE, LOSS OF PROFITS, INCONVIENCE, COMMERCIAL LOSS OR OTHER INCIDENTAL OR CONSEQUENTIAL DAMAGES WHATSOEVER.**