



PT-25KSI-3

**Operators
Manual**

Power Technology Southeast, Inc.

634 State Road #44 Leesburg, FL 34748-8103

◆ (352) 365-2777 ◆ Fax (352) 787-5545 ◆

FORWARD

You are now the proud owner of a Power Technology Generator powered by a Kubota engine. This engine is a product of Kubota's quality engineering and manufacturing. The engine is made with fine materials and manufactured under the strictest quality control standards and will assure you long satisfactory service. To obtain the best use of your engine, please read this manual carefully. It will help you become familiar with the operation of the engine and contains many helpful hints regarding engine maintenance. Continuing improvements and advancements in product design may have caused changes to your engine, which are not included in this manual.

Please contact Power Technology's Customer Service Department for latest information on your Kubota engine or for the number of your local Kubota dealer.

TO OUR CUSTOMERS

THANK YOU FOR YOUR PURCHASE OF A POWER TECHNOLOGY GENERATOR. THE INFORMATION CONTAINED IN THIS MANUAL APPLIES TO PT-20KSI-2 GENERATORS. IN THE EVENT YOU EXPERIENCE A PROBLEM WITH YOUR GENERATOR PLEASE CONTACT THE SALES DEALER, ONE OF OUR AUTHORIZED SERVICE CENTERS OR POWER TECHNOLOGY'S CUSTOMER SERVICE DEPARTMENT DIRECTLY AT 1-800-760-0027 FROM 8:00 A.M. TO 5:00 P.M. EST. PARTS MAY BE OBTAINED DIRECTLY THROUGH POWER TECHNOLOGY AND SHIPPED THE SAME DAY IF ORDERED BY 3:00 P.M. EST. IF REQUIRED, A MAJOR SERVICE MANUAL MAY BE ORDERED THROUGH POWER TECHNOLOGY'S CUSTOMER SERVICE DEPARTMENT.

PLEASE HAVE THE GENERATOR MODEL AND SERIAL NUMBERS AVAILABLE WHEN YOU CALL. THIS WILL HELP EXPEDITE SERVICE AND PARTS TO YOU.

Generator Model Number _____

Generator Serial Number _____

POWER TECHNOLOGY SOUTHEAST, INC.
634 STATE RD. 44
LEESBURG, FL. 34748-8103
(352) 365-2777
FAX (352) 787-5545
www.PowerTech-Gen.com



Limited Warranty on Power Tech Generators

Power Technology Southeast, Inc. warrants to you, the original purchaser, that each product of our manufacture is free from defects in materials, and workmanship. That each generator will deliver its rated output as indicated on The Power Technology Nameplate, if properly installed, serviced, and operated under normal conditions in accordance with Power Technology's instructions.

THE WARRANTY COVERAGE TERMS:

2 years from date of purchase, or 3000 hours whichever comes first, or 36 months from the date of manufacture. Parts, and labor, including diagnostic labor, removal, and reinstallation are covered for the first 12 months from date in service or 1000 hours whichever comes first.

Parts and labor are covered only on the following generator and engine parts for 2 years or 3000 hours whichever comes first. Generator Parts: Main Rotor and Main Stator. Engine Parts: Cylinder Block, cylinder head, crankshaft, camshaft, cylinder head gears, connecting rods, flywheel and flywheel housing, intake and exhaust manifold (only if flexible connection is used).

- 3) Stand-by Units are covered for a period of 1 year from date of installation, or 1000 hours, or 24 months from the date of manufacture whichever comes first.
- 4) Replacement Parts are warranted: 30 days. (Excluding the following: voltage regulators, fuses, controllers, capacitors, brushes, and switches)

WHAT POWER TECHNOLOGY WILL DO:

Power Tech will at our option, repair or replace any part covered by this warranty which becomes defective, malfunctions or otherwise fails to conform to this warranty under normal use and service during the term of this warranty.

WHAT YOU MUST DO TO OBTAIN WARRANTY SERVICE:

In order to obtain warranty repairs you must deliver the product, together with proof of purchase to an authorized Power Tech service facility. In the case of repairs pertaining to the engine only, you must use an authorized dealer or distributor of that make of engine, to be covered under their warranty. Engines used in the manufacture of Power Tech products are warranted solely by the engine manufacturer.

PRIOR APPROVAL IS REQUIRED FOR ANY WARRANTY SERVICE

Failure to obtain authorization prior to the repair being performed will result in the claim being denied.

All claims must be submitted within 30 days of the repair. Along with the following: a copy of the original repair order, Power Tech authorization number, Power Tech serial number, and operation hours shown on the genset mounted hour meter.

THIS WARRANTY DOES NOT COVER THE FOLLOWING:

A. Normal wear items, including but not limited to: turbo-chargers, fuel injector (s), starter, alternator, and electronic components, as well as normal engine and/or generator wear. **A1.** Travel time and fuel charges to and from the repair facility or travel time and fuel charges for mobile service. (Except stationary units with a maximum of 2-hours travel time.) **B.** Defects, malfunctions or failure resulting from accidents, abuse, misuse, improper servicing, improper installation, improper storage, and lack of performance of required maintenance service. **C.** Products which have been subjected to alteration, modification, neglect or unauthorized repairs. **D.** Troubleshooting, routine service, tune-ups, replacement of filters, belts, coolant, lubricants, hoses, clamps, exhaust system components, fuel system components, gaskets and/or seals. **E.** Electrical items damaged by welding or jump-starting. **F.** Damage caused by water ingestion or electrolysis. **G.** Damage caused by ingestion of substances other than clean filtered air, fuel, or intake water. **H.** Damage caused by faulty repairs performed by a repair facility not authorized in writing by Power Tech. **I.** Damage caused by operation with improper fuel or at speeds, loads, conditions, modifications, or installation contrary to published specifications or recommendations. **J.** Original installation charges and startup costs. **K.** Removal and re-installation charges of more than 1-hour labor for outside units, 2-hours for compartment mounted units, and 3-hours for below deck marine units. Customer is responsible for additional labor/charges due to difficult access, removal or installation. **L.** Starting batteries and labor or charges related to battery service. **M.** Loss of revenue or the rental of equipment due to down time. **N.** Generator repairs made within the warranty period other than by an authorized Power Tech service dealer without prior written approval from Power Tech warranty department. **O.** Damage caused by negligent maintenance such as but not limited to: Failure to provide the specified type and quantity of lubricating oil, cooling air flow, and proper coolant mixture and level. Failure to provide adequate air intake/or maintenance of the air intake system. Failure to provide scheduled maintenance as prescribed in supplied manuals. **P.** Engine fluids such as fuel, oil or coolant/antifreeze. **Q.** Shop supplies such as adhesives, cleaning agents, rags, paint, or other miscellaneous supplies. **R.** Use of other than factory supplied or approved repair parts or procedures. Replacement of a failed Power Tech component with a non-Power Tech component voids the Power Tech warranty on that component and any and all failures related to that component. **S.** Fuel injection pumps repaired by anyone other than the factory authorized dealer or distributor of that engine. **T.** Expenses incurred investigating performance complaints unless defective Power Tech materials or workmanship are discovered. **U.** Generator sets used in rental applications. **V.** Cleaning, service, or repair of generator sets that have not been kept free of dirt, debris, or other items that prevent the unit from being able to operate properly. **W.** Any generator set not application approved. **X.** Loss of excitation due to prolonged storage. **Y.** Any damage attributed to low battery monitoring or automatic generator starting systems. **Z.** Optional accessories are warranted solely by the manufacturer of that item including but not limited to the following item: Block heaters, oil pan heaters, electric cooling fans, air-bag isolators, compartment heaters, fuel tanks, trailers, battery chargers, battery monitors.

To obtain warranty service: For your nearest Power Tech authorized service center, on the World Wide Web at: http://www.powertech-gen.com/parts_service.php

Call 1-352-365-2777 or write to Power Tech Warranty Department, P.O. Box 490133 Leesburg, FL 34749 USA.

Power Tech must be notified in writing within five (5) business days of any product failure.

General Conditions:

This Warranty is the sole property of the original owner /user.

A transfer of ownership shall terminate this Warranty.

This Warranty is only valid within the contiguous United States and Canada.

Warranty coverage is available outside the U.S. and Canada; please speak to a factory representative for those details.

This Warranty does not cover any products or parts not purchased from Power Technology.

Power Technology reserves the right to make design improvements and model changes without any obligation to change units or parts previously manufactured.

Warranty registration card must be completed and mailed to Power Tech at the above address to validate the Warranty.

This is the only express warranty on Power Tech products

No person, agent, or dealer is authorized to give any Warranties on behalf of Power Technology Southeast, Inc., and not to assume for Power Technology Southeast, Inc. any other liability in connection with any of its products unless made in writing and signed by an officer of Power Technology Southeast, Inc.

LIMITATIONS ON OUR RESPONSIBILITY WITH RESPECT TO PRODUCTS PURCHASED AND USED FOR PERSONAL, FAMILY OR HOUSEHOLD USE:

Our responsibility is to repair or replace defective parts as stated above. We will not be responsible for any other expenses, losses or inconvenience which you may Sustain as a result of the purchase, use, malfunction or defective condition of our products. **ANY IMPLIED WARRANTIES, INCLUDING WARRANTIES OF MERCHANTABILITY OR FITNESS FOR A PARTICULAR PURPOSE SHALL BE LIMITED IN DURATION TO THE PERIOD SET FORTH ABOVE.**

Some states do not allow limitations on how long an implied Warranty lasts or the exclusion or limitation of incidental or consequential damages, so the above

Limitations or exclusions may not apply to you. This Warranty gives you specific legal rights and you may have other rights which vary from state to state.

This Warranty is in lieu of all other Warranties, expressed or implied and of any other obligations or liability on our part.

Our responsibility for any and all losses and **IN NO EVENT WILL WE BE LIABLE FOR LOSS OF USE, LOSS OF PROFITS, INCONVIENCE, COMMERCIAL LOSS OR OTHER INCIDENTAL OR CONSEQUENTIAL DAMAGES WHATSOEVER.**

TABLE of CONTENTS

SECTION 1:

“SAFETY”

SAFE OPERATION _____	1-4
----------------------	-----

SECTION 2:

“ENGINE”

PRE-OPERATION CHECK _____	1
OPERATING THE ENGINE _____	2
ENGINE SPECIFICATIONS _____	3
ENGINE MAINTENANCE SERVICE SCHEDULE _____	4
ENGINE OIL MAINTENANCE _____	5
ENGINE COOLANT MAINTENANCE _____	6
OPERATING HOURS AND SERVICE LOG _____	7

SECTION 3:

“GENERATOR END”

PRINCIPLES OF OPERATION _____	1-2
“M” SERIES EXCITER TYPE GENERATOR ASSEMBLY _____	3
WIRING SCHEMATICS and RESISTANCE CHARTS _____	4-5

SECTION 4:

“INSTALLATION”

SAFETY PRECAUTIONS _____	1-2
GENERATOR INSTALLATION in RECREATIONAL VEHICLES _____	3-8
SYSTEMS CONNECTION _____	9-12
ELECTRICAL CONNECTIONS _____	13-16

SECTION 1 “SAFETY”

SAFE OPERATION

1-4

Observe Safety Instructions
Wear Safety Clothing
Check Before Operating the Engine
Keep Area Around the Engine Clean
Safe Handling of Fuel and Lubricants
Exhaust Gases and Fire Prevention
Escaping Fluids
Cautions Against Burns and Battery Explosion
Keep Hands and Body Away From Rotating Parts
Anti-Freeze and Disposal of Fluids
Conducting Safety Checks and Maintenance



This symbol, the industry’s “Safety Alert Symbol”, is used throughout this manual and on labels attached the machine itself. It warns of the potential for personal injury. It is essential that you carefully read the instructions and safety regulations before you attempt to assemble or use this unit.



WARNING: Indicates a potentially hazardous situation, which may possibly result in serious injury or possible death.



CAUTION: Indicates a potentially hazardous situation, which may possibly result in minor injury.

IMPORTANT: Indicates that equipment or property damage may result if instructions are not followed.

NOTE: Indicates helpful information.

SAFE OPERATION

Cautious operation is your best insurance against an accident. Read and understand this section carefully before operating the engine. All operators, no matter how knowledgeable they may be, should read this and other related manuals before operating the engine or any equipment attached to it. It is the owner's responsibility to instruct all operators in safe operation. Be sure to observe the following for safe operation.

OBSERVE SAFETY INSTRUCTIONS

- Read, understand and follow this "OPERATORS MANUAL" and "LABELS ON THE ENGINE" before starting and operating the engine.
- Learn how to operate and work safely. Know your equipment and its limitations. Always keep the engine in good condition.
- Before allowing other people to use your engine, explain how to operate and have them read this manual before operation.
- DO NOT modify the engine. UNAUTHORIZED MODIFICATIONS to the engine may impair the function and/or safety and affect engine life.

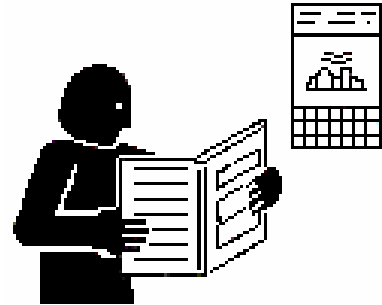

WEAR SAFETY CLOTHING

- DO NOT wear loose, torn or bulky clothing around machinery. Entanglement in rotating parts, controls or projections may cause personal injury.
- Use additional safety items, e.g. hardhat, eye protection, gloves, etc., as appropriate or required.
- DO NOT operate machinery or equipment while under the influence of alcohol, medication, or other drugs, or while fatigued.
- DO NOT wear radio or music headphones while operating engine.



CHECK BEFORE OPERATING THE ENGINE

- If the engine is malfunctioning DO NOT operate until repairs are made.
- Be sure all guards and shields are in place before operating the engine. Replace any that are damaged or missing.
- Check to see that the area around the engine is clear of foreign objects before starting.
- Always keep the engine at least 3 feet (1 meter) away from buildings or other facilities.
- DO NOT allow children or livestock to approach the machine while in operation.
- DO NOT start the engine by shorting across starter terminals.



KEEP AREA AROUND THE ENGINE CLEAN

- Be sure to stop the engine before cleaning.
- Keep the engine clean and free of accumulated dirt, grease and trash.
- DO NOT stop the engine without idling; Temperatures around the engine rises suddenly. Keep the engine idling for about 5 minutes before stopping.



SAFE HANDLING OF FUEL AND LUBRICANTS

- Always stop the engine before refueling or lubricating.
- DO NOT smoke or allow flames or sparks in your working area. Fuel is extremely flammable and explosive. Never store flammable liquids in the engine compartment.
- Refuel at a well-ventilated and open place. If fuel or lubricants spill, clean up immediately and properly dispose of.
- DO NOT mix gasoline or alcohol with diesel fuel. The mixture can cause a fire.



EXHAUST GASES AND FIRE PREVENTION

- Engine exhaust fumes can be very harmful if allowed to accumulate. Be sure to run the engine in a well-ventilated area where there are no people or livestock near by.
- The exhaust gas from the muffler is very hot. To prevent a fire, do not expose dry grass, oil or any other combustible materials to exhaust gas. Keep the engine and mufflers clean all the time.
- To avoid a fire, be alert for leaks of flammables from hoses and lines. Be sure to check for leaks from hoses and pipes, such as fuel and hydraulic by following the maintenance check list.
- To avoid a fire, do not short across power cables and wires. Check to see that all power cables and wires are in good condition. Keep all power connections clean. Bare wire or frayed insulation can cause a dangerous electrical shock and personal injury.



CALIFORNIA
Proposition 65 Warning

Diesel Engine Exhaust and some of its constituents are known by the State of California to cause Cancer, Birth Defects and Other Reproductive harm.

ESCAPING FLUIDS

- Relieve all pressure in the air, oil and cooling systems before any lines, fittings or related items are removed or disconnected.
- Be alert for possible pressure release when disconnecting any dev from a system that is pressurized. **DO NOT** check for pressure leaks with your hands. High-pressure oil or fuel can cause personal injury.
- Escaping hydraulic fluid under pressure has sufficient force to penetrate skin causing serious personal injury.
- Fluid escaping from pinholes may be invisible. Use a piece of cardboard or wood to search for suspected leaks: do not use hands and body. Use safety goggles or other eye protection when checking for leaks.
- If injured by escaping fluid, see a medical doctor immediately. This fluid can produce gangrene or severe allergic reaction.

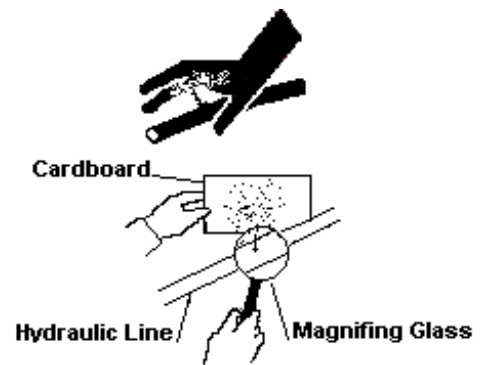

CAUTIONS AGAINST BURNS AND BATTERY EXPLOSION

- To avoid burns, be alert for hot components during operation and just after the engine has been shut off. Such as the muffler, muffler cover, radiator, piping, engine body, coolants, engine oil, etc.
- **DO NOT** remove the radiator cap while the engine is running or immediately after stopping. Wait approximately ten minutes for the radiator to cool before removing the cap.
- Be sure the radiator drain valve / petcock and hose clamps are tighten. Check radiator pressure cap and oil fill cap before operating the engine.
- The battery presents an explosive hazard. When the battery is being activated, hydrogen and oxygen gases are extremely explosive.
- Keep sparks and open flames away from the battery, especially during charging. **DO NOT** strike a match near the battery.
- **DO NOT** check a batteries charge by placing a metal object across the terminals. Use a voltmeter or hydrometer.
- **DO NOT** charge a battery if frozen, it may possibly explode. Frozen batteries must be warm up to at least 61°F (16°C) before charging.

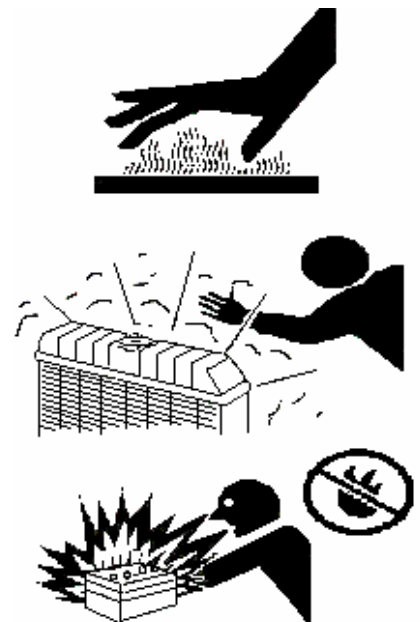

KEEP HANDS AND BODY AWAY FROM ROTATING PARTS

- Keep your hands and body away from all rotating parts, such as cooling fan, v-belts, pulleys and flywheel. Contact with these rotating parts can cause serious personal injury.
- Be sure to stop the engine before adjusting belt tension or checking the cooling fan.
- **DO NOT** run the engine without safety guards installed. Be sure the safety guards are properly aligned and securely fastened before operating the engine.

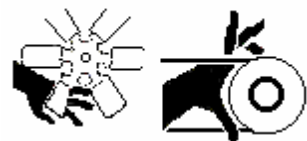

ANTI-FREEZE AND DISPOSAL OF FLUIDS

- Anti-freeze contains toxic chemicals. Wear rubber gloves when handling anti-freeze. In case of contact with skin, wash immediately to avoid personal injury.
- DO NOT mix different types of Anti-freeze. The mixture can produce a chemical reaction resulting in the formation of harmful substances. Only use anti-freeze that is recommended and approved by Caterpillar.
- Be mindful of the environment. Before draining any fluids, be prepared to dispose of them in a manner consistent with environmental protection regulations in your location.
- When draining fluids from the engine, use appropriate containers to hold the different fluids, do not mix fuel, oil or coolant together.
- Dispose of spent filter cartridges and batteries properly.
- DO NOT pollute the soil, or any water source. Never pour fluids down a drain.



CONDUCTING SAFETY CHECKS AND MAINTENANCE

- When performing safety checks or engine service, be sure the engine is level and well supported. Use approved stands designed for this type of service. DO NOT service an engine that is only supported by a lift jack or hoist.
- Detach the battery from the engine before conducting service. Put a “DO NOT OPERATE!” tag in the key switch to avoid accidental starting.
- To avoid sparks from an accidental short circuit always disconnect the 12V DC power at the battery.
- Be sure to stop the engine and remove the key when conducting daily and periodic maintenance, servicing and cleaning.
- Check or conduct maintenance after the engine, radiator, muffler, or muffler cover has cooled off completely.
- Always use the appropriate tools and jig-fixtured when performing any service work. Be sure to understand and follow the instructions included with these tools.
- Use ONLY correct engine barring techniques for manually rotating the engine. DO NOT attempt to rotate the engine by pulling or prying on the cooling fan and V-belt. Serious personal injury or damage to the cooling fan may occur.
- Replace fuel hoses and hose clamps every 2 years or earlier whether they are damaged or not. They are made of rubber and are aged gradually.
- When service is performed with two or more people present, take care to perform all work safely. Be aware of their location especially when starting the engine.
- Keep a first aid kit and fire extinguisher handy at all times.

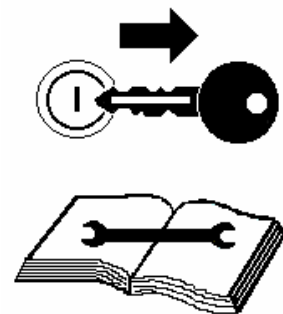

SECTION 2
“ENGINE”

PRE-OPERATION CHECK _____	1
Engine Break-in Period	
Daily Check	
OPERATING THE ENGINE _____	2
Engine Starting Controls	
Check Engine After Starting	
Stopping the Engine	
ENGINE SPECIFICATIONS _____	3
Kubota Model V-2203 MBG	
Service Parts	
ENGINE MAINTENANCE SERVICE SCHEDULE _____	4
ENGINE OIL MAINTENANCE _____	5
Checking Engine Oil Level	
Lubricating Oil Specifications	
Engine Refill Capacities	
Lubricating Oil Viscosity Recommendations	
ENGINE COOLANT MAINTENANCE _____	6
Coolant Recommendations	
Ethylene Glycol / Propylene Glycol	
Checking Radiator Coolant Level	
Coolant Service Life	
Checking Reservoir Tank Coolant Level	
Cleaning Radiator Core	
OPERATING HOURS AND SERVICE LOG _____	7

PRE-OPERATION CHECK

ENGINE BREAK-IN PERIOD

During the engine break-in period, observe the following recommendations:

Change the engine oil and oil filter cartridge after the first 50 hours of operation.
(See “ENGINE OIL” in ENGINE MAINTENANCE SERVICE SCHEDULE).

In ambient temperature above 32°F (0°C) approximately 3-5 minutes without a load is sufficient for engine warm up. Allow additional warm up time when temperatures are below 32°F (0°C) before placing an operating load on the engine.

DAILY CHECK

To prevent future engine problems from occurring, it is important to know and keep track of the engine's condition. Below are items to be inspected and checked on a daily basis.

CAUTION:

To avoid personal injury:

- Be sure all safety shields and guards are attached to the engine when operating.
- To prevent a fire hazard, keep foreign materials, fuel and oil away from the battery, wiring, muffler and engine. Check and clear them daily. Be aware of the muffler and exhaust gas heat underneath engine compartment, this heat may ignite grass or other flammable materials.
- Follow all safety precautions as outlined in the “SAFE OPERATION” section.

For accurate readings the engine should be on level ground when checking engine fluids.

Check fluids before starting the engine. (Cold Engine)

- Lubrication System: Check Engine oil level
 Check for Engine oil leaks
- Cooling System: Check coolant level and condition
 Check for coolant leaks
 Check for proper installation of the radiator cap
- Fuel System: Check for sufficient quantity of fuel
 Check for fuel leaks

Check engine after starting. (Warm Engine)

- Proper Operation: Check for easy engine start
 Check for fluid leaks
 Check for abnormal engine noises
 Check for abnormal exhaust gas

OPERATING THE ENGINE

ENGINE STARTING CONTROLS

- 1) Generator Main Switch must be in the ON position.
- 2) Hold Start/Stop Switch for 1 second and release.
- 3) Glow Plugs will preheat for 8 seconds. LED flashes slowly.
- 4) Preheating will cease during engine cranking cycle. LED continues flashing.
- 5) Engine begins an 8 seconds crank cycle, After 4 seconds of cranking the PT-ECU-63 will check for an AC signal from the generator. If an AC signal is verified the engine will start and the LED will remain ON during the normal run operation. If the AC signal is not verified the PT-ECU-63 will terminate the cranking cycle and LED will flash a fault code.
- 6) Starter disengages immediately after engine run is verified.
- 7) PT-ECU-63 deactivates the Low Oil Pressure and High Water Temperature Switches for 6 seconds, this will assure oil pressure build-up time. If oil pressure does not build-up the engine will immediately shut down and go into a fault mode. Likewise for a high temperature situation.
- 8) If engine will not start on the first attempt the PT-ECU-63 will initiate the start cycle 2 more times before going into a fault mode. Glow Plugs will preheat for 8 seconds per attempt. Engine will crank for 8 seconds per attempt.
- 9) To shut down the engine under normal operations, hold the Start/Stop Switch for 1 second and release.
- 10) If a fault occurs turn Generator Main Switch OFF and then ON to reset PT-ECU-63.

CHECKING ENGINE AFTER STARTING

- 1) Allow the engine to warm up 3 to 5 minutes before applying a load. In colder climates allow a few extra minutes longer.
- 2) Perform a visual inspection of all areas of the engine and generator.
- 3) Listen for any abnormal noises.
- 4) Check for any abnormal exhaust gases.

STOPPING THE ENGINE

It is recommended to disconnect or reduce the power load from the generator before shutting down the engine. Then follow the steps outlined above for normal shut down.

NOTE: The PT-ECU-63 is designed to operate on 12V DC power. In a low battery situation the PT-ECU-63 may not initiate the normal cranking cycle. To start the generator you can press and hold the Start/Stop Switch for approximately 10 seconds or until the engine starts. Once the engine starts the PT-ECU-63 will resume normal operations. If this situation re-occurs, charge or replace the battery.

IMPORTANT: Damage to the Starter Motor, Starter Solenoid, Run Solenoid or any generator component due to excessive or prolonged starting attempts attributed to an external Low Battery Control Monitoring or Auto-Start System will not be covered by the Power Technology Southeast, Inc. Limited Warranty.

ENGINE SPECIFICATIONS

MODEL V-2203 MBG

Air Induction	Naturally Aspirated
Continuous Output	32.5 HP @ 1800 rpm
Cubic Capacity	134.07 in ³ (2.19L)
Bore and Stroke	3.43 x 3.64 (87x92.4mm)
Cylinder Arrangement	4 In-Line
Firing Order	1-3-4-2
Compression Ratio	23:1
Engine Oil Capacity	8.5 qts. (8.04L)
Fuel and Type	Diesel 4 Cycle
Minimum Fuel Consumption	See Specification Chart

SERVICE PARTS

Power Technology Part

Filters:

Oil ----- 01FO091
Fuel ----- 08FF081
Air with Plastic Canister----- 04FA2E1

Belts:

Alternator ----- 03BF0203

Engine Maintenance Service Schedule

Maintenance Item	*See Note	Daily	Min. Every 25 Hours	Every 100 Hours	Every 250 Hours	Every 500 Hours	Every 1000 Hours	Remarks
Oil Level		X						
Oil Change	*			X				Or Once a Year
Filter				X				Or Once a Year
Oil Level		X						
Oil Leakage		X						
Oil Change							X	Or Once a Year
Level		X						As Necessary
Leakage		X						
Filter Re-ment						X		Or Once a Year
Filter Re-ment	**					X		Or Once a Year
aged Worn Hose Belts		X						Or Every Two Years
Check Fuel							X	Or Every Two Years
Radiator & Clamps						X		Once a Year
Normal Engine		X						
Normal Motor Noise		X						
Motor Condition		X						
Test Gas Emission		X						

* Engine oil and filter must be changed after the first 50 hours of operation. Then every 100 hours or once a year whichever comes first.

** Air filter replacement interval will vary depending on operating conditions. Adverse conditions may require frequent service.

NOTE: Under normal operation items such as Belts, Hoses and Filters are not covered by Power Technology Southeast, Inc. Limited Warranty.

ENGINE OIL MAINTENANCE

CHECKING ENGINE OIL LEVEL

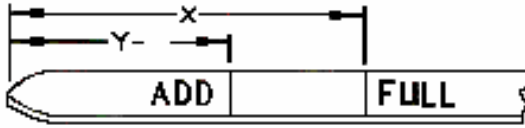

(Y) “ADD” mark. (X) “FULL” mark.

1. Maintain the engine oil level between “ADD” mark and “FULL” mark on oil level gauge. Do not fill crankcase above “FULL” mark.
2. Remove the oil filler cap and add oil, if necessary. Clean the oil filler cap. Install the oil filler cap.

The refill capacities for the engine crankcase Reflect the approximate capacity of the crankcase or sump plus a standard oil filter. Auxiliary oil filter systems will require additional oil.

LUBRICATING OIL SPECIFICATION

Use only good quality lubricating oil, which meets the following Specification

API Class
CF
Engine Oil

KUBOTA V-2203 MBG REFILL CAPACITIES

Crankcase Oil Sump and Filter 8.5 Qts. (8.04L)

LUBRICATING OIL VISCOSITY RECOMMENDATIONS

The minimum ambient temperature during cold engine start-up and the maximum ambient temperature during engine operation determine the proper SAE viscosity grade of oil.

Refer to the Engine Oil Viscosity Table below (Minimum Temperature) in order to determine the required oil viscosity for starting an engine in cold conditions.

Refer to the Engine Oil Viscosity Table below (Maximum Temperature) in order to select the oil viscosity for engine operation at the highest ambient temperature that is anticipated.

Ambient Temperature	Oil Viscosity
Above 25°C (77°F)	SAE 10W-30 SAE 30 or SAE 10W-40
0 to 25°C (32° to 77°F)	SAE 10W-30 SAE 20 or SAE10W-40
Below 0°C (32°F)	SAE 10W-30 SAE 10W or SAE 10W-40

ENGINE COOLANT MAINTENANCE

COOLANT RECOMMENDATIONS

For optimum performance, Power Technology recommends a 1:1 mixture of water / glycol.

NOTE: Use a mixture that will provide protection against the lowest ambient temperature.

NOTE: 100 percent pure glycol will freeze at a temperature of -23°C (-9°F).

Most conventional heavy-duty coolant / antifreezes use Ethylene Glycol. Propylene Glycol may also be used in a 1:1 mixture with water. Ethylene and Propylene Glycol provide similar protection against freezing and boiling. See the tables below.

ETHYLENE GLYCOL

<u>Concentration</u>	<u>Freeze Protection</u>	<u>Boil Protection</u>
50 Percent	-36°C (-33°F)	106°C (223°F)
60 Percent	-51°C (-60°F)	111°C (232°F)

PROPYLENE GLYCOL

<u>Concentration</u>	<u>Freeze Protection</u>	<u>Boil Protection</u>
50 Percent	-29°C (-20°F)	106°C (223°F)

NOTE: Do not use Propylene Glycol in concentrations that exceed 50 percent glycol because of Propylene Glycol's reduced heat transfer capability. Use Ethylene Glycol in conditions that require additional protection against boiling or freezing.

CHECKING RADIATOR COOLANT LEVEL

Remove the radiator cap after the engine has completely cooled and check to see that coolant reaches the supply port.

1. Fill to the bottom of the fill neck and check after every 25 hours of operation.

COOLANT SERVICE LIFE

<u>Coolant Type</u>	<u>Service Life</u>
Commercial Heavy-Duty Coolant/Antifreeze that Meets "ASTM D5345"	3000 Service Hours or Two Years
Commercial Heavy-Duty Coolant/Antifreeze that Meets "ASTM D4985"	3000 Service Hours or One Year

NOTE: Do not use a commercial coolant/antifreeze that only meets the ASTM D3306 or D4656 specification. This type of coolant/antifreeze is made for light duty automotive applications.

CHECKING RESERVOIR TANK COOLANT LEVEL

(At a Minimum of 25 Hours of Operation)
Ensure that the coolant level of the radiator reservoir tank is between the upper limit (FULL) and the lower limit (LOW) on the side of the reservoir tank.

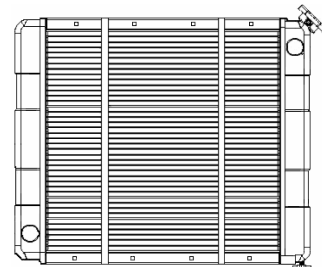

CLEANING RADIATOR CORE

Visually inspect the core for any obstructions such as dirt or debris. Use running water to clean particles from between fins.

IMPORTANT: Never use hard objects to clean radiator core, damage to core could result.

GENERATOR ASSEMBLY INFORMATION

EXCITER TYPE GENERATOR

The exciter pole pieces contain residual magnetism, which sets up lines of force across the air gap to the exciter armature. When the exciter begins to rotate a voltage is induced and current flow is initiated in the exciter armature AC windings. This voltage is fed to the rotating rectifier assembly, rectified and fed to the alternator field, which sets up lines of force across the air gap to the alternator stator windings and to the output circuit.

A static voltage regulator is connected to the generator output. The regulator will rectify part of the output voltage to provide a DC voltage to the exciter field coils. This will increase the density of the lines of force in the exciter, increasing the voltage induced into the exciter armature windings, and therefore, to the rotating rectifiers. The rotating rectifier output will be increased which will increase the alternator field strength and generator output will build up its rated voltage. Adjustment of the generator output to the rated voltage level is accomplished by controlling the current fed to the exciter field coils. Regulation is automatic with the static type voltage regulator. An additional voltage adjustment range is provided if desired by turning the Voltage Adjust Rheostat.

ELECTRONIC VOLTAGE REGULATION

Electronic Voltage Regulator (EVR) also referred to, as an Automatic Voltage Regulator (AVR) is a very reliable device, which uses solid-state electronics to maintain voltage accuracy at $\pm 2\%$ of the regulated voltage. The Voltage Regulator is designed to automatically regulate and maintain the generated AC voltage through out the load range, that is from no load to full load.

VOLTAGE CONNECTION

The generator may be connected at the terminal board to deliver 120/240 volts to a 3 wire grounded neutral system, or 120-volts only to a 2 wire distribution system. If any equipment requires 240-volts, then the 120/240-volt connection must be used. If all equipment requires 120-volts then the 120-volt connection is preferred, even if two lines leave the same switch box. The two lines at the inputs to the switch box are both connected to the un-grounded 120-volt lines from the generator. The 120-volt connection enables the Electronic Voltage Regulator (EVR) to hold the voltage very close to the 115 or 120 volts, as initially adjusted, regardless of the power distribution amount the different distribution lines. The 120-volt connection is recommended if the entire electrical load requires only 115 or 120 volts.

Although the 120/240-volt connection may also be used when all loads requires only 110 volts, it should be pointed out that this connection, the 240-volts, is regulated and the lightly loaded phase, or line, will deliver a high line to neutral voltage and the heavily loaded phase will deliver a low line to neutral voltage. The heavily loaded line may have such a low voltage that air conditioning will have more difficulty in starting, and long starting lines may overload generator and trip circuit breakers

EXCITER FIELD COIL VOLTAGE SOURCE

Field coil DC voltage is obtained by rectifying the voltage from the phase to neutral line of the generator output, or either appropriate terminal to provide the needed voltage reference.

The rectifier bridge is an internal part of the static regulator. The static regulator senses a change in the generator output and automatically regulates current flow in the exciter field coil circuit to increase or decrease the exciter field strength. An adjustable rheostat sized to be compatible with the regulator is used to provide adjustment of the regulator sensing circuit.

SECTION 4 “INSTALLATION”

SAFETY PRECAUTIONS _____	1-2
Hot Piping	
Dangerous Fuels	
Explosive Battery Gases	
Electrocution	
Moving Parts	
High Voltage	
Explosion	
Hot Coolant	
Lethal Exhaust Gas	
Excessive Noise	
Electrical Shock	
Backfire	
Flash Fire	
Fire Hazard	
Marine Application	
Unit Starts Without Notice	
Loose Components	
GENERATOR INSTALLATION in RECREATIONAL VEHICLES _____	3-8
Introduction	
Marine Application	
General Information	
Specification Charts	
Fuel Consumption in Gallons per Hour	
Installation Factors	
Generator Compartment Size	
Compartment Frame	
Air Requirements	
Air Requirements Cont'd	
Enclosure View and Dimensions	
Base Pan Dimensions and Outlets	
SYSTEMS CONNECTION _____	9-12
Remote Radiator Cooling System	
Fuel System	
Exhaust System	
Fuel Line Diagram	
ELECTRICAL CONNECTIONS _____	13-16
Electrical Wiring	
AC Load Lead Connections	
Motor Loads	
Kilowatt De-Rating	
Electrical Loads	
Appliance Loads	
Extension Cords	
BASLER AVC 63-4	

SAFTEY PRECAUTIONS

A generator set can be potentially dangerous if not properly maintained and operated. The best Safe Guard against a dangerous situation is education, good judgment and common sense. For safe trouble free operation of your generator set some general precautions are listed below. Be sure to read, understand and follow these precautions. Please call Power Technology Southeast, Inc. with any concerns you may have with your generator set.

- 1) **HOT PIPING:** An engine and exhaust system may get extremely hot while running. Do not work on a generator set until it has sufficiently cooled.
- 2) **DANGEROUS FUELS:** Use extreme caution when handling, storing and using fuels. All fuels are highly explosive in a vaporous state. Store fuel in a well ventilated area away from spark producing equipment. Keep fuels and all chemicals out of the reach of children. Never add fuel to the tank while the engine is running. Spilled fuel may ignite on contact with hot parts or from ignition spark. Always keep fuel lines and connections tight and in good condition. Don't replace flexible fuel lines with rigid lines. If you notice any fuel leakage, fuel accumulation or electrical sparks, **DO NOT OPERATE THE GENERATOR SET.**
- 3) **EXPLOSIVE BATTERY GASES:** The gases generated by a battery being charged are highly explosive. Do not smoke or permit any flames or sparks to occur near a battery at any time, especially when it is being charged. Avoid contact between terminals with tools to prevent sparks and possible burns. Always remove wristwatch, rings, or other jewelry before handling a battery. Any compartment containing batteries should be well ventilated to prevent the accumulation of explosive gases. To avoid sparks never disturb the battery charging connections while the battery is being charged. Always turn off the battery charger before disconnecting terminal clips.
- 4) **ELECTROCUTION:** Failure to install a generator set with an electrical system consistent with governing regulations and standards is **UNLAWFUL** and may cause **ELECTROCUTION** of vehicle occupants. Your generator set must not be used to "Back Feed" by connecting it to a building or outdoor electrical circuit. Back feeding can cause serious injury or death to utility personnel working to repair a power outage and may also seriously injure persons in your vehicle. Unauthorized connections are unlawful in some states and/or localities. A transfer switch must be installed to prevent interconnection of the generator set power and outside power.
- 5) **MOVING PARTS:** Keep hands, feet, and clothing away from belts and related pulleys when unit is running. Replace guards, covers, and screens before operating the generator set. Serious personal injury may occur from contact with moving parts.
- 6) **HIGH VOLTAGE:** Remember the function of a generator set is to produce electricity. Wherever electricity is present there is a potential danger of electrocution. Apply the same precautions to the vehicles electrical appliances as you would for any home appliance. Keep away from electrical circuits and wiring while the generator set is running. Have electrical service performed only by qualified electricians. Be sure any unauthorized person; especially children are denied access to the generator set. Keep the compartment door securely latched or locked at all times. Be sure the generator is properly grounded. Never touch electrical leads or appliances with wet hands, or when standing on wet ground.

- 7) **EXPLOSION:** Never connect the negative (-) battery cable to the positive (+) connection terminal of the starter solenoid, or test the battery by shorting terminals together. This could ignite fuel vapors or cause the battery to explode. To disconnect the battery remove the negative battery cable first and reconnect it last. Do not modify the fuel tank or propulsion engine fuel system. Your vehicle must be equipped with a fuel pick-up arrangement as described in the Fuel System section of this manual. Fuel tank and installation must conform to applicable regulations.
- 8) **HOT COOLANT:** Allow engine to cool and release pressure from the cooling system before opening the radiator pressure cap. To release the pressure, cover the radiator cap with a thick cloth then turn it slowly counterclockwise to the first stop. After the pressure is released and the engine has cooled, remove the cap.
- 9) **LETHAL EXHAUST GAS:** When installing an exhaust system position the tail pipe end so that the discharged gases may not be drawn into the vehicle interior through windows, doors, air conditioners, etc. The engine powering your generator set discharges deadly carbon monoxide as part of the exhaust gas when running. It is essential that the exhaust system be leak proof and routinely inspected.
- 10) **EXCESSIVE NOISE:** Never operate the generator set without an adequate muffler or with a faulty exhaust system. Exposure to excessive noise can lead to a hearing impairment.
- 11) **ELECTRICAL SHOCK:** A battery can cause electrical burns and shocks. Use reasonable care when working near the battery to avoid electrical connections by contacting the battery terminals with tools. Remove wristwatch, rings and all jewelry when working on the generator set.
- 12) **BACKFIRE:** A sudden backfire can cause serious burns. Do not operate your generator set without its air cleaner / flame arrestor in place.
- 13) **FLASH FIRE:** A sudden flash fire can cause serious burns. To avoid the possibility of a flash fire do not smoke or permit a flame or spark to occur near the carburetor, fuel lines, fuel filter, fuel pump or other potential source of spilled fuel or vapors.
- 14) **FIRE HAZARD:** Be careful when parking your vehicle to prevent grass fires from being started by hot exhaust gases or exhaust system. Keep away from hot engine and generator parts to avoid burning yourself. Keep the generator set and compartment clean and free of debris, especially combustible materials. Never store fuel, oil or rags in the generator compartment.
- 15) **MARINE APPLICATION:** RV generator sets do not comply with United States Coast Guard (USCG) requirements. They must not be used for marine applications. Use only generator sets specified for marine use in a marine application. USCG regulation 33CFR183 requires a generator set to be ignition protected for use in a gasoline-fueled environment.
- 16) **UNIT STARTS WITHOUT NOTICE:** To prevent accidental starting on the units with remote start / stop switch, always disconnect the battery by removing the negative (-) terminal first and then the positive (+). Always disconnect the unit in this manner before working on the generator or any equipment connected to it.
- 17) **LOOSE COMPONENTS:** Periodically check for and tighten any fasteners that may have become loose from vibration or road shock. Serious damage may possibly occur if components become dislodged or misaligned.

GENERATOR INSTALLATION In RECREATIONAL VEHICLES

INTRODUCTION

Use this section as a guide when installing a generator set in a recreational vehicle, and then refer to the appropriate operation section for specific instructions. When installing a RV generator set the installation must comply with the current Safety Standards of ANSI / RVIA EGS-1-2003, ANSI A 119.2 / NFPA 501C and applicable articles of ANSI / NFPA 70 of the National Electrical Code. Generator set installations must also comply with state and local requirements.

MARINE APPLICATION

RV generator sets do not comply with United States Coast Guard (USCG) requirements and must not be used for marine applications. Use only generator sets specified for marine use in marine installations. USCG regulation 33CFR183 requires a generator set to be “ignition protected” when used in a gasoline fueled environment.

GENERAL INFORMATION

This information section covers the RV generator set models listed below. To determine which model is involved, check the model number found on the Power Technology nameplate attached to the frame of the generator being installed. Follow all instructions to ensure proper installation and operation.

Each generator set features a Kubota diesel engine, rotating-field alternating current generator, and a control box. The generator is directly connected to the engine for permanent alignment. Each control box includes a Start / Stop switch, and a On /Off switch to reset the control module or lockout any remote switch to prevent starting while service is being performed. The control box may also be equipped with a switch to operate the mechanism used to move the generator in/out of the coach for servicing. (Supplied by the coach manufacture). After the set is attached to the frame of the vehicle, all that is usually required to make it operational are the following.

1. Attaching the exhaust system.
2. Add proper amount of radiator coolant.
3. Add oil to crankcase, to the dipstick FULL mark.
4. Connect fuel lines, remote switch, load leads and battery terminals.

(Consult the Specification Charts on the Following Pages for Requirements)

MODEL	PTRV-20KSI-RR
DIMENSIONS L x W x H	45-1/4" x 24-1/4" x 27"
WEIGHT	850 lbs.
ENGINE	Kubota V-2203 MBG
RPMs	1800
KW RATING	20
AC VOLTAGE	120 / 240
AMPERAGE	166/83
Hz	60
PHASE	1
GENERATOR COMPARTMENT	500
FREE AIR OPENING	Square Inches
RADIATOR AIR REQUIREMENTS	2120 CFM

SPECIFICATION CHARTS

FUEL CONNECTION	1/8"NPT & 1/4" NPT
FUEL RECOMMENDATION	DIESEL FUEL No.1-D or No.2-D ASTM / D975
BATTERY VOLTAGE	12 VOLTS DC
BATTERY CRANKING AMPS	420
BATTERY COLD CRANKING AMPS	590 MINIMUM
BATTERY GROUND	NEGATIVE
CHARGING AMPS.	40

FUEL CONSUMPTION IN GALLONS PER HOUR

LOAD PERCENTAGE	20KW
25%	.45 GPH
50%	.90 GPH
75%	1.35 GPH
100%	1.80 GPH

INSTALLATION FACTORS

Each generator set is received as a unit except for the optional exhaust system components, which are shipped loose for assembly after the set is installed in the vehicle. When preplanning the installation, the following factors must be considered.

1. COMPARTMENT SIZE: Will there be sufficient room around the set to maintain the minimum clearance requirements?
2. AIR REQUIREMENTS: Are the compartment air inlets and outlets sized to allow adequate circulation of air for cooling and combustion?
3. COMPARTMENT FLOOR: Is the compartment floor strong enough to support the weight of the generator set?
4. COOLING SYSTEM: Is the cooling system large enough to adequately cool the generator set? **
5. FUEL SYSTEM: Is the fuel system properly designed to prevent fuel starvation of either the main engine or generator engine?
6. EXHAUST SYSTEM: Will the exhaust system meet all Local, State and Federal safety requirements?
7. ELECTRICAL CONNECTIONS: Will all systems, (battery, load and remote switch) be compatible with the vehicles system?

**** NOTE:** When using a radiator not supplied by Power Technology consult your radiator manufacturer to ensure that heat rejection values are met.

GENERATOR COMPARTMENT SIZE

In planning the size of the generator compartment allow for the minimum clearance of (3) inches at the connection end and one (1) inch at all other sides is necessary to adequately cool the generator set. The thickness of insulation and sound deadening material used to line the compartment must be taken into consideration when planning this clearance. To maintain minimum clearance it may be necessary to enlarge the compartment.

NOTE: For Gensets mounted inside an enclosure please refer to the section on “Generator Enclosures” for additional information and mounting requirements.

The generator set must be securely fastened to avoid unwanted movement from vibration and road shock. If the unit is equipped with a mounting tray the tray is usually supported with structural framing. Be sure to use all mounting holes in the tray to secure the tray to the structural framing. Units not equipped with mounting tray are secured by attaching Genset mounts (two front and two rear) directly to the structural framing. Skid mounted units can either be affixed to a tray for tray mounting or attached directly to the structural framing. The generator is easily moved in and out of the coach by incorporating a slide rack carriage with rollers into the structural framing. When designing the compartment allow sufficient access for routine maintenance and for removal when major service is required. Also keep in mind that the compartment or door must have an air intake opening equal to or greater than that specified under the “Air Requirements” section of this manual. Make sure that the compartment is vapor tight and completely sealed off from the inside of the vehicle to prevent any hazardous fumes from entering the vehicle. Avoid road splash and the possibility of igniting combustible materials beneath the coach by enclosing all unnecessary free space beneath the generator compartment. Line the compartment with a good sound deadening material. The material selected must be fireproof or highly fire resistant. 3-layer foam sound mat is very efficient for absorbing generator noise. This type of material is easily cut to size and can be quickly installed using the appropriate fire resistant adhesive. Other materials such as fiberglass insulation with heat barrier may also be used.

NOTE: Since a Genset is flexibly mounted the minimum clearance of one (1) inch will assure that the unit will not rub the sides of the compartment while the unit is in operation or while the vehicle is in transit.

COMPARTMENT FRAMING

The generator must be bolted to a structural frame, which is either bolted or welded to the frame of the vehicle. This structural frame must be designed to withstand a minimum force of 5Gs in any direction. The structural frame must support the entire outer perimeter and center section of the unit’s base. Additional framing may be required if excessive movement or vibration occurs.

AIR REQUIREMENTS

Each Genset is equipped with a high ambient temperature shutdown switch and a high water temperature shutdown switch, which will automatically shut down the Genset if the ambient temperature or water temperature rises too high. To prevent the generator set from shutting down make sure the compartment openings are large enough to allow adequate circulation of cooling air. The minimum free air opening into the compartment is 500 sq. in. or 3225 sq. cm. Remember that louvers, screens and protective grills will restrict airflow. A relatively open mesh screen can restrict airflow by as much as 45%. The intake opening will need to be increased in size to compensate for such restrictions.

NOTE: Ambient temperature is defined as the generators normal operating temperature within its mounting area. In an RV application this area is referred to as a compartment or enclosure.

AIR REQUIREMENTS CONT'D

	20KW
ENGINE SPEED IN RPM	1800
OUTPUT IN HORSEPOWER	32.5
WATER FLOW – GAL. / MIN.	8.75
ENGINE INLET WATER TEMP.	N/A
THERMOSTAT – RATING	180°F
THERMOSTAT FULL OPEN	195°F
ENGINE OUTLET WATER TEMP. MAX.	235°F
HIGH TEMP. SHUTDOWN SWITCH	230°F
HEAT REJECTION – BTU / MIN.	1650
HEAT REJECTION – BTU / HR.	99,000
REMOTE RADIATOR AIR FLOW – CU. FT. / MIN.	1920
ENGINE OIL TEMP. MAX.	268°F
COMBUSTION AIR TEMP. *	N/A

*Combustion Air Temperature: The output of the engine will decrease about 1% for every 10°F of air temperature above 77°F or 25°C.

IMPORTANT: Insulation and Sound Absorbing Material used inside of the generator compartment Must Not reduce the specified airspace clearance of one (1) inch or restrict the airflow around the generator. Such reduction in airspace may lead to an overheating situation and reduced generator performance. Also be sure the air inlet and outlet openings meet the specified requirements. Allow clearance inside the generator compartment for easy access when routine maintenance is required.

WARNING: The generator compartment Must Be sealed to prevent hazardous fumes and vapors from entering the vehicles other compartments and interior spaces. Plugging holes and sealing all seams will greatly reduce this hazard.

WARNING: Drip Proofing! When installing a generator, the area directly beneath the generator end of the unit must incorporate a non-flammable barrier. This barrier needs to be made of sufficient material able to withstand and prevent molten metal, burning insulation, flaming or sparking particles from penetrating the compartment floor or dripping beneath the compartment.

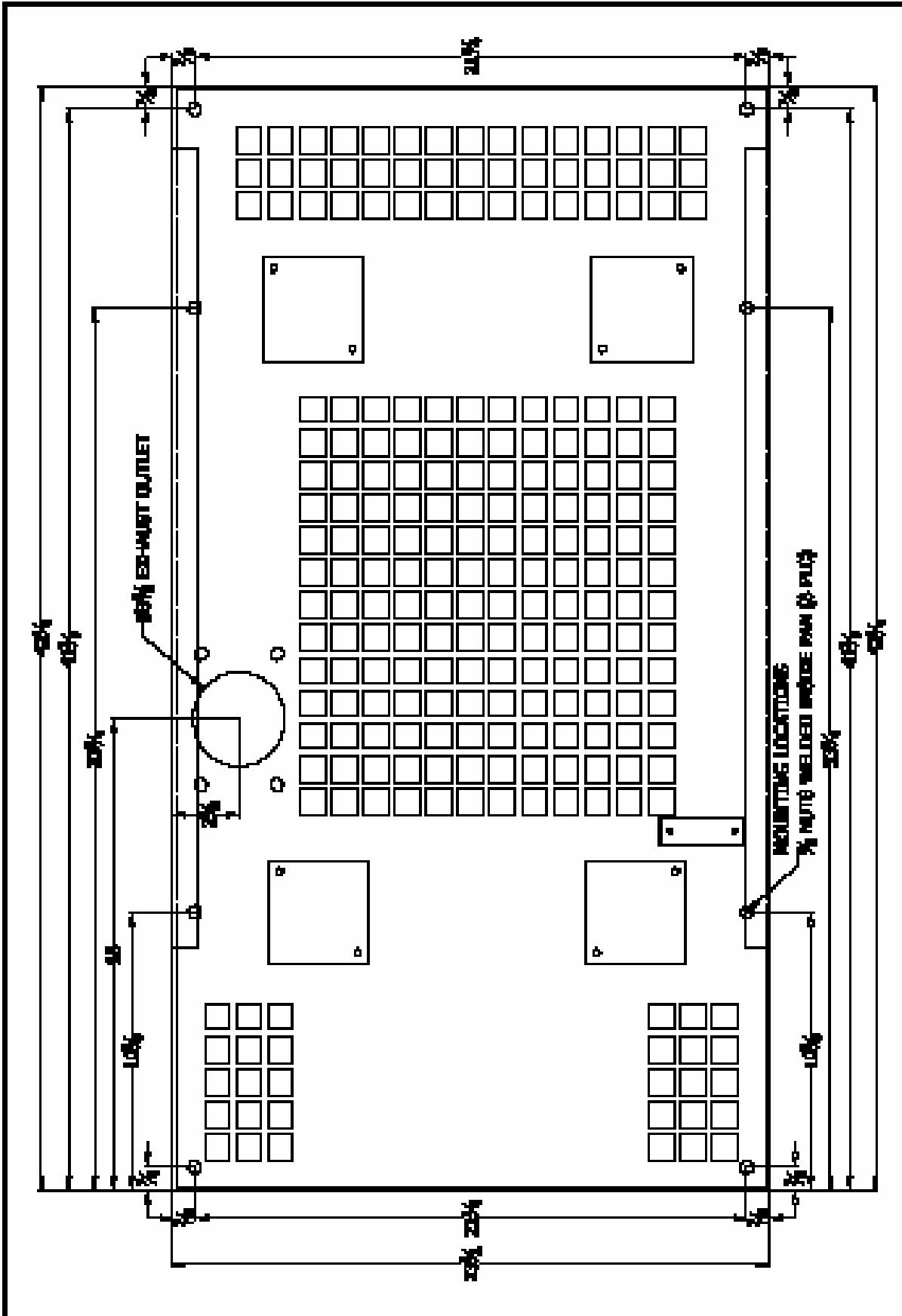

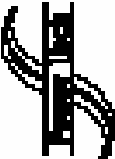
		POWER TECHNOLOGY INTERNATIONAL, INC. 10000 W. 10th Street Suite 100 Denver, CO 80202	
PROJ. NO. _____ TYPE _____ DATE _____ REV. NO. _____	POWER TECHNOLOGY TYPE _____ DATE _____ REV. NO. _____	PROJECT NO. _____ DATE _____ REV. NO. _____	SCALE _____
FIG. NO.		FIG. NO.	
FIG. NO.		FIG. NO.	

SYSTEMS CONNECTION

FUEL SYSTEM

The diesel fuel system for the generator set must be designed to operate independently from the vehicles main engine if both engines are to be operated at the same time. The best way to do this is to have separate fuel tanks, but this is usually impractical because of space restrictions. In most installations both engines operate from a common fuel tank with separate pick-up tubes for each engine, not a Tee fitting arrangement. This prevents either or both engines from being starved for fuel. The generator set fuel pick-up tube is generally shorter than the vehicles; therefore fuel may not be available to the generator when fuel supply is low. This will prevent the generator from depleting the fuel supply needed by the main engine.

NOTE: Using a simple Tee fitting to supply both engines from a common fuel line is not recommended. This practice may possible cause a fuel starvation situation to either or both engines. Also, if excessive pressure were to build up in the main supply line it could possible cause a failure of the generators fuel lines or connectors and a hazardous fuel leak may occur.

Care must be taken when routing the fuel line from the main tank to the generator set. Keep the fuel line as short as possible while maintaining adequate clearance from the exhaust system. Fuel lines must be run along the frame side rails or coach under carriage. Never run fuel lines inside of the coach. Securely fasten the fuel lines with hardware that is recommended for the type of fuel line used. The fuel lines should enter the generator compartment at a point nearest to the generators fuel line connection fittings. Allow for a minimum of 8 inches of flexible fuel line to make the connection. Use proper size fuel line to accommodate the fuel flow needed. Steel fuel line or high quality fuel hose is recommended, either one should have a minimum of 1/4" ID and strong enough to withstand road and climatic conditions.

EXHAUST SYSTEM

Exhaust system components will vary from one installation to another; therefore a muffler and tailpipe may not always be furnished with the Genset. However, it is imperative to install a muffler and tailpipe to reduce exhaust noise and direct exhaust gases beyond the vehicles perimeter and away from the normal head-on air stream. Install a tail pipe with as few bends as possible to prevent excessive backpressure. A properly installed exhaust system must be vapor tight, quiet and completely safe for the vehicle, its occupants and surroundings. Installation of an approved Spark Arrestor is required.

The exhaust system components must be approved and properly installed to meet the codes and regulations required by Federal and State agencies. Exhaust Mufflers and Spark Arrestors supplied by Power Technology meet code and standard requirements set forth by the USDA Forest Service.

Laws pertaining to application and maintenance of a Spark Arrestor may vary depending on your location and State regulations. Federal laws apply on Federal lands. If a generator is used in a forest, on brush or grass covered unimproved land it must be equipped with a Spark Arrestor. It is the responsibility of the vehicle owner or operator to install and maintain the entire exhaust system in good working condition.

CAUTION: Any person (s) who installs an unapproved Muffler, Spark Arrestor or other exhaust system component, and/or modifies an exhaust system or component that may result in a hazardous condition is liable for damages, injuries or warranty expense caused by such unapproved installation and/or modification.

EXHAUST SYSTEM

IMPORTANT SAFETY TIPS:

When exhaust system components are not furnished by Power Technology as part of the Genset, the installer is responsible for meeting the following requirements.

- 1) Only use exhaust system components, which do not restrict exhaust flow. A restricted exhaust system will create excessive backpressure and may cause poor engine performance and possible engine damage. The maximum allowable backpressure for the engines listed in this manual is 1.57in Hg, (40mmHg).
- 2) Muffler shall be fabricated of aluminized steel or other corrosion resistant material and be of a welded or crimp construction. A USDA Forest Service approved spark arrestor must be part of the integral design of the muffler or provided as a separate add-on item.
- 3) Maintain a minimum of 3 inches (76mm) between the exhaust system components and any surrounding combustible materials. If the minimum clearance cannot be maintained, an insulating shield must be installed to prevent the combustible material from exceeding temperatures of 117°F (65°C) above ambient temperature.
- 4) Extend the exhaust system a minimum of 1 inch (25mm) beyond the vehicles perimeter. Never terminate the exhaust system underneath the vehicle.
- 5) Terminate the exhaust system in a direction, which prevents the exhaust gases from being drawn back into the generator compartment and re-circulated.
- 6) If the exhaust system is located in an area which may become susceptible to road damage from curbs, speed bumps, or other road obstacles a protective device such as a skid bar or plate should be installed.
- 7) To prevent excessive movement and vibration of the exhaust system, install hangers and clamps designed for use in exhaust systems.
- 8) Never join or tee the generator exhaust system and the vehicle exhaust system together. Doing so may cause excessive back pressure on the generator engine, also condensation from one engine can damage the other engine.

WARNING: LETHAL EXHAUST GAS! When installing the exhaust system position the tail pipe end so that discharged exhaust gases are not drawn into the vehicle interior through windows, doors, air conditioners, etc. During operation an engine discharges deadly carbon monoxide with its exhaust. Carbon monoxide is particularly dangerous since it is odorless, tasteless, and non-irritating. It can cause death if inhaled for even a short period of time. Be especially careful if operating the generator set when parked under calm, windless conditions. Gases may accumulate in these conditions. Park your vehicle so that the exhaust discharges downwind. Always be aware of others in your vicinity. Make sure that your exhaust discharges away from other vehicles and buildings.

CAUTION: Make sure the exhaust system components are positioned well away from drain openings beneath the generator set. Also, be sure not to block access to the oil drain plug.

 POWER TECHNOLOGY SOUTHEAST, INC.
634 STATE ROAD 44
LEESBURG, FLORIDA 34748-8102
(352)365-2777 FAX (352)787-5545

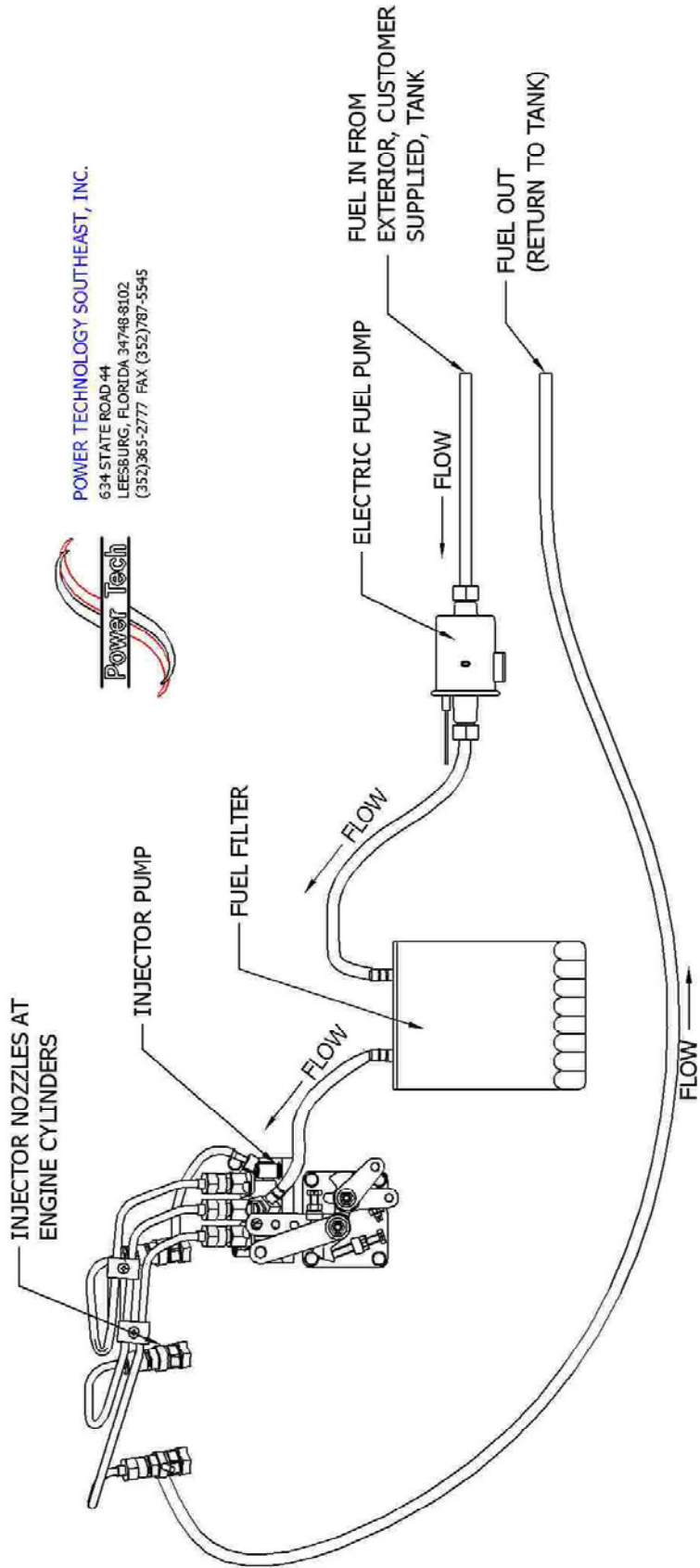

TYPICAL FUEL LINE DIAGRAM

ELECTRICAL CONNECTIONS

ELECTRICAL WIRING

All wiring must be applicable with local electrical codes. A qualified licensed electrician must perform all electrical wiring connections. Ground Fault (GFCI) breakers must be installed to protect all vehicle branch circuits. All switches and controls must be securely mounted to prevent damage and accidental opening or closing from vibration, road shock and vehicle motion.

Battery, load leads and the remote switch panel connections are necessary for completing the installation. Make final connections to the battery only after all other connections have been made, as this will prevent unintentional starting. Some specific details on each connection are stated in the following paragraphs. Refer to the wiring diagram for specific details. All wiring to the generator set shall be securely supported or harnessed to prevent abrasion. Additional support is required to prevent exposure to the exhaust system and any possible leakage of fuel, oil, or grease. At least 2 inches of clearance must be maintained between electrical wiring and hot exhaust parts. Wiring must not be located directly below or close to the fuel system, oil fill and drain locations. If the coach is equipped with a mechanism for removing the generator set from the compartment such as a mounting base or slide rack, be certain all wiring is long enough to allow for free movement of the generator for servicing.

A separate 12-volt battery is recommended for the generator set. With a separate battery, cables should be kept short in length thus eliminating problems with excessive voltage drop. See the Table below for cable size (AWG) to length requirements.

NOTE: A heavy gauge #4 ground strap must be connected between the ground lug on the generator set and the frame of the vehicle. All wiring connections made at the time of installation should be readily accessible for periodic inspection and servicing.

DISTANCE BETWEEN GENERATOR SET AND BATTERY	CABLE SIZE (AWG) REQUIREMENTS AT VARIOUS TEMPERATURES		
	0°F (-18°C)	32°F (0°C)	75°F (24°C)
40' (12.2M)	00	0	1
30' (9.2M)	0	1	2
25' (7.6M)	1	2	4
20' (6.1M)	2	2	6
15' (4.6M)	2	4	6
10' (3.0M)	4	6	8
5' (1.5M)	6	6	8
2.5' (0.8M)	8	8	8

AC LOAD LEAD CONNECTIONS

Some generator sets have four color-coded leads. The Black leads (L1 & L3) are hot. The White or Gray lead (L2) is neutral and the Green lead is ground. The load leads can be routed directly from the junction box to the vehicle AC circuit or transfer switch connection. All installations require that the load leads be routed through flexible conduit from the generator end bracket to the junction box location. The load lead junction box must be accessible for servicing and inspection.

AC load lead (L2) White or Gray is always the neutral lead on PTS generator sets. Make sure the neutral of the AC circuit in the vehicle is connected to the (L2) White or Gray lead. If equipment ground type plugs and receptacles (3 prong) are used in the vehicle, the green wire must be connected to the chassis ground. On vehicles, which also have provisions for using an outside AC, power source, the neutral lead as well as the Black (L1 & L3) hot leads must be completely isolated from the generator set when power is switched to the outside source.

MOTOR LOADS

When figuring generator set capacity requirements for installation involving motor loads, do not overlook the high current demanded by the motor during start-up. The “In-Rush” of starting current may be 2 to 5 times higher than that required when the motor reaches normal operating speed. Reserve capacity must be allowed for in rush demands plus other loads, which could be on the line as the motor starts.

Air conditioning units are the most common type of motor loads for a generator set in a recreational vehicle. The starting characteristics of the different makes of air conditioners vary greatly. For example, a particular 12,000 BTU unit may have lower starting requirements than a 10,000 BTU unit of another make. When only one unit is involved there is usually no starting problem provided of course the lighting and appliance load is not too high when unit is started. The trend seems to be toward larger capacity air conditioners and the use of more than one unit in larger vehicles. Simultaneously starting two large units can present a problem if the capacity is marginal. Because of the variation in starting characteristics of the different makes of air conditioners, no definite statement can be made in this publication regarding multiple-motor starting capabilities.

Delayed starting or use of “easy starting” devices on air conditioner units should be considered whenever simultaneous starting of more than one motor is involved. The starting and running requirements of some motor loads common to mobile applications are listed in the table below. Use this as a guide when selecting generator set capacity requirements involving motor loads. Also note the Kilowatt De-rating factor for generator set capabilities regarding air conditioners. Capabilities will vary according to “Kilowatt De-rating”.

ELECTRIC MOTOR HORSEPOWER	BASED ON CODE “G” ELECTRIC MOTOR	
	STARTING WATTS	RUNNING WATTS
½	2000	1100
1	3800	1800
2	6000	2800
3	8000	4000
4	11000	5500
5	13000	6500

KILOWATT DE-RATING

All units are rated at 1.0 power factor. The Kilowatts of the generator set will decrease 3.5% per 1,000 feet (305m) above 500 feet (152m) above sea level. De-rate 1% for every 10 °F (5.5°C) above 68°F.

ELECTRICAL LOADS

While the electrical load of the vehicle should have been calculated prior to purchase of the generator set, you may want to recheck the load before installing the set to make sure the capacity is ample to meet the demands without possible overloading.

The lighting load is usually easiest to calculate in most cases, simply add the wattage of each lamp to be operated off the generator set. Note that in many applications, not all of the lights or lamps are in the generator sets AC circuit. Some are DC powered by the 12-volt battery in the vehicle. Make sure the total includes only lights actually on the generator sets AC circuit. The lighting load is usually not too heavy in mobile installations however it must be accurately calculated to prevent overloading. For example, if all lights are on at the same time and the air conditioner or other motor equipment starts up, this may possibly cause an overload situation.

APPLIANCE LOADS

Generator sets in recreational vehicles are often used to supply AC voltage for appliances. With the exception of a resistance-type load such as a water heater, requirements for appliances are usually low. However, such loads must not be overlooked when calculating the total wattage requirements. To avoid an overload situation, reserve capacity should also be calculated for unanticipated appliance loads. The average power requirements for some common electrical appliances are listed below as a guide.

DETERMINING ALTERNATOR LOAD REQUIREMENTS		
CHECK ✓	APPLIANCE	WATTS REQUIRED
	VCR	70
	LIGHT BULB	100
	RADIO	100
	TELEVISION	100
	STEREO	100
	FRY PAN	150
	HOME COMPUTER	150
	VACUUM CLEANER	250
	ATTIC FAN 1/4 HP	400
	SUMP PUMP 1/3 HP	500
	REFRIGERATOR	500
	FURNACE FAN 1/3 HP	600
	FREEZER	800
	JET WATER PUMP 3/4 HP	900
	ELECTRIC STOVE ELEMENT	1000
	SUBMERSIBLE WATER PUMP 1 HP	1000
	TOASTER	1000
	COFFEE MAKER	1200
	DISHWASHER	1200
	HAIR DRYER	1200
	MICROWAVE OVEN	1500
	SUBMERSIBLE WATER PUMP 2 HP	1600
	WATER HEATER	3000
	OVEN	4500
	TOTAL WATTS CHECKED	

EXTENSION CORDS

An extension cord is normally used to provide electrical power from the generator set to a remote location. The extension cord size (AWG#) and length must be adequate to safely maintain the amperage requirements. A proper size extension cord will help minimize the voltage drop between the generator set and remote location.

AMPS	LOAD IN WATTS		CORD LENGTH		
	120 VOLTS	240 VOLTS	AWG#10	AWG#12	AWG#14
5	600	1200	500 FT	300 FT	200 FT
10	1200	2400	250 FT	150 FT	100 FT
20	2400	4800	125 FT	75 FT	50 FT
30	3600	7200	60 FT	35 FT	25 FT
40	4800	9600	30 FT	15 FT	10 FT
50	6000	12000	15 FT	-----	-----

ENGINE TROUBLE SHOOTING

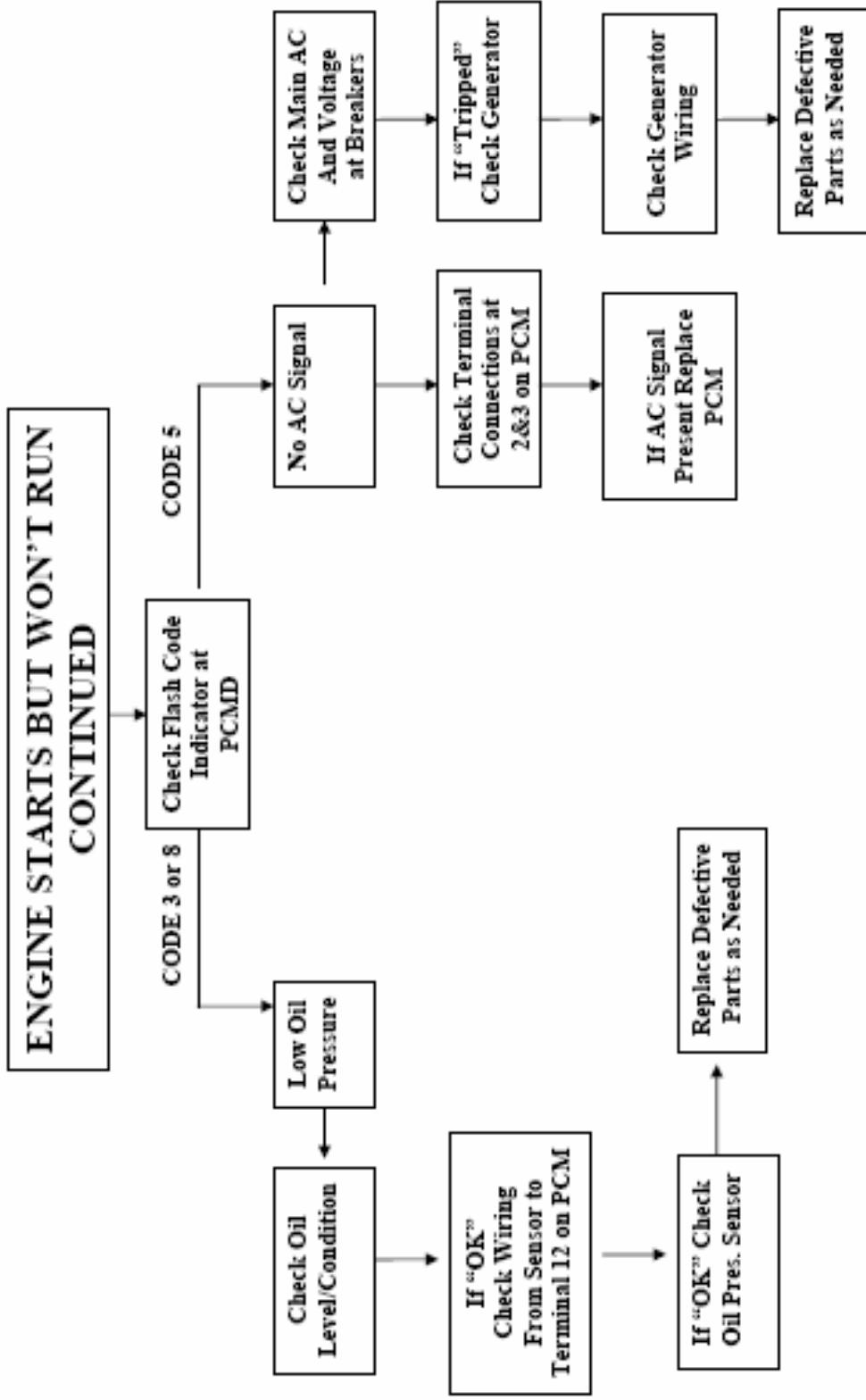

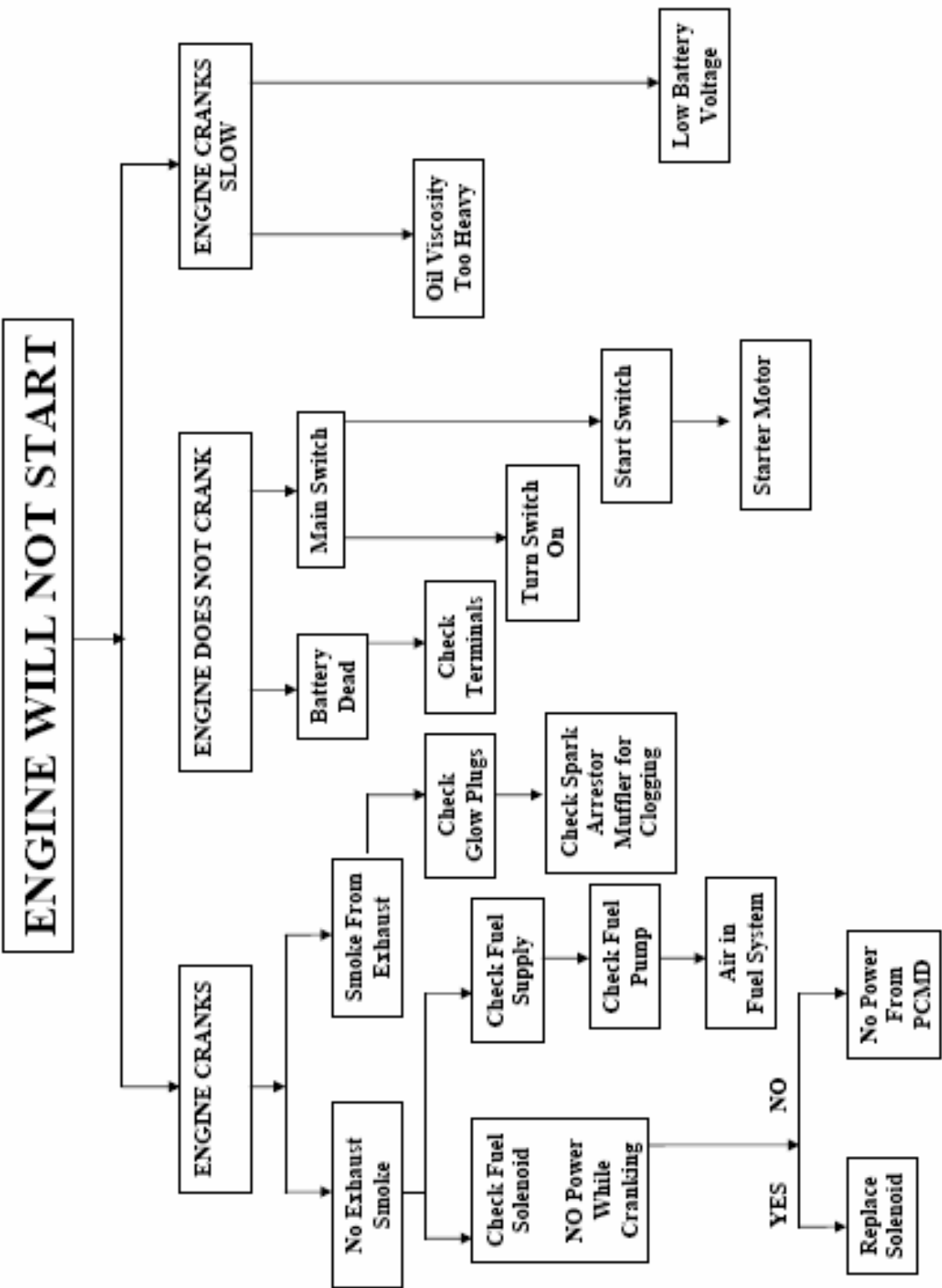

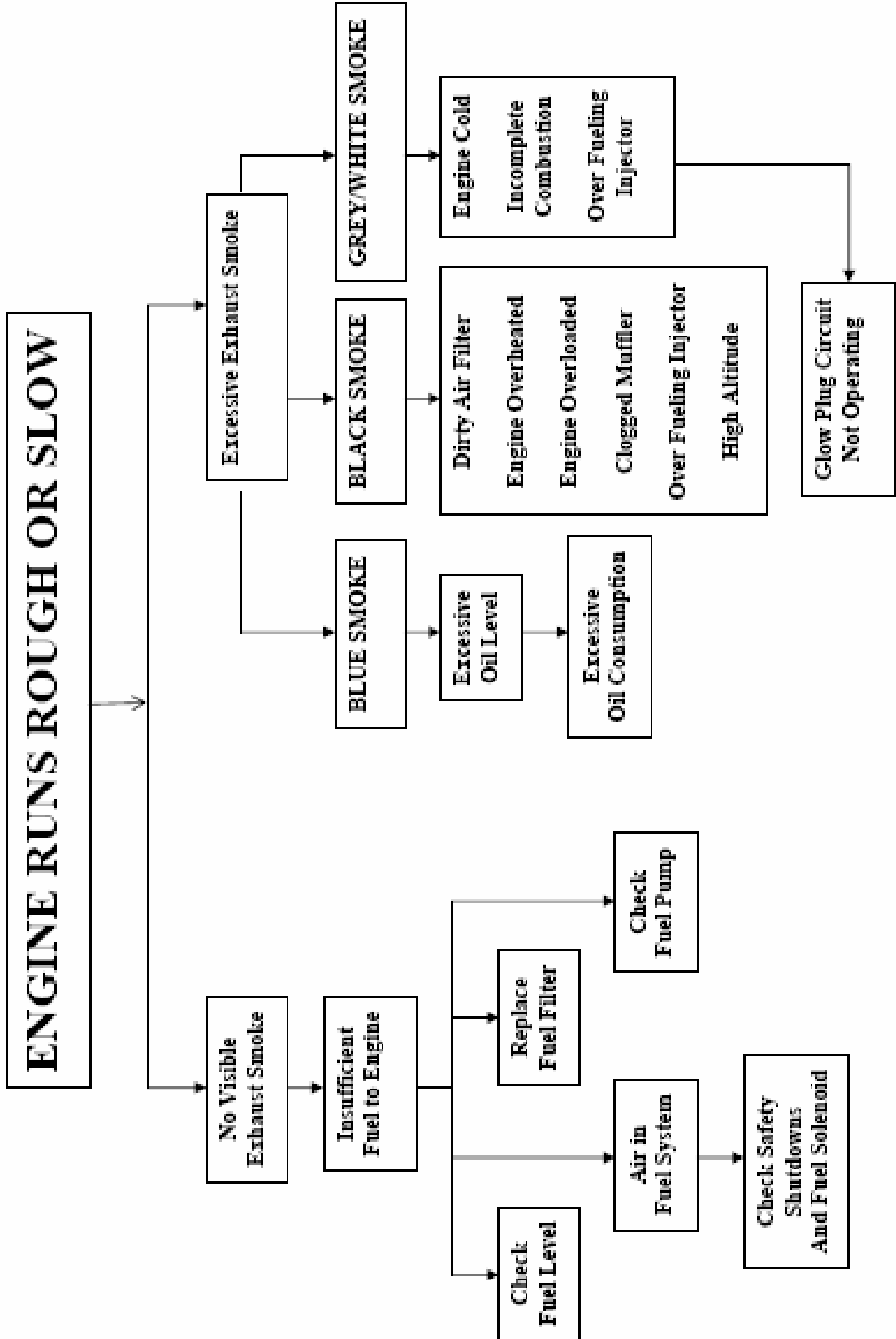

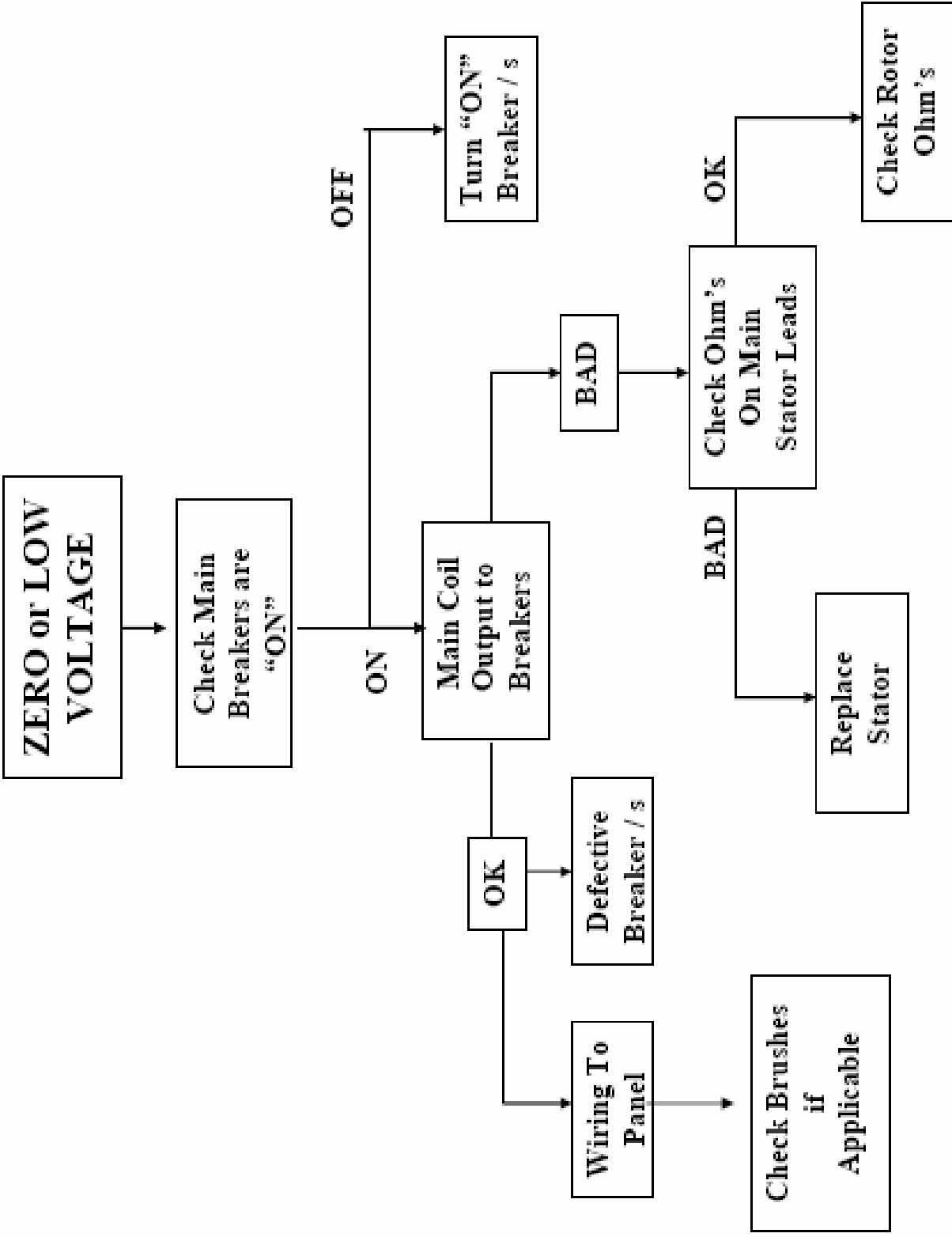

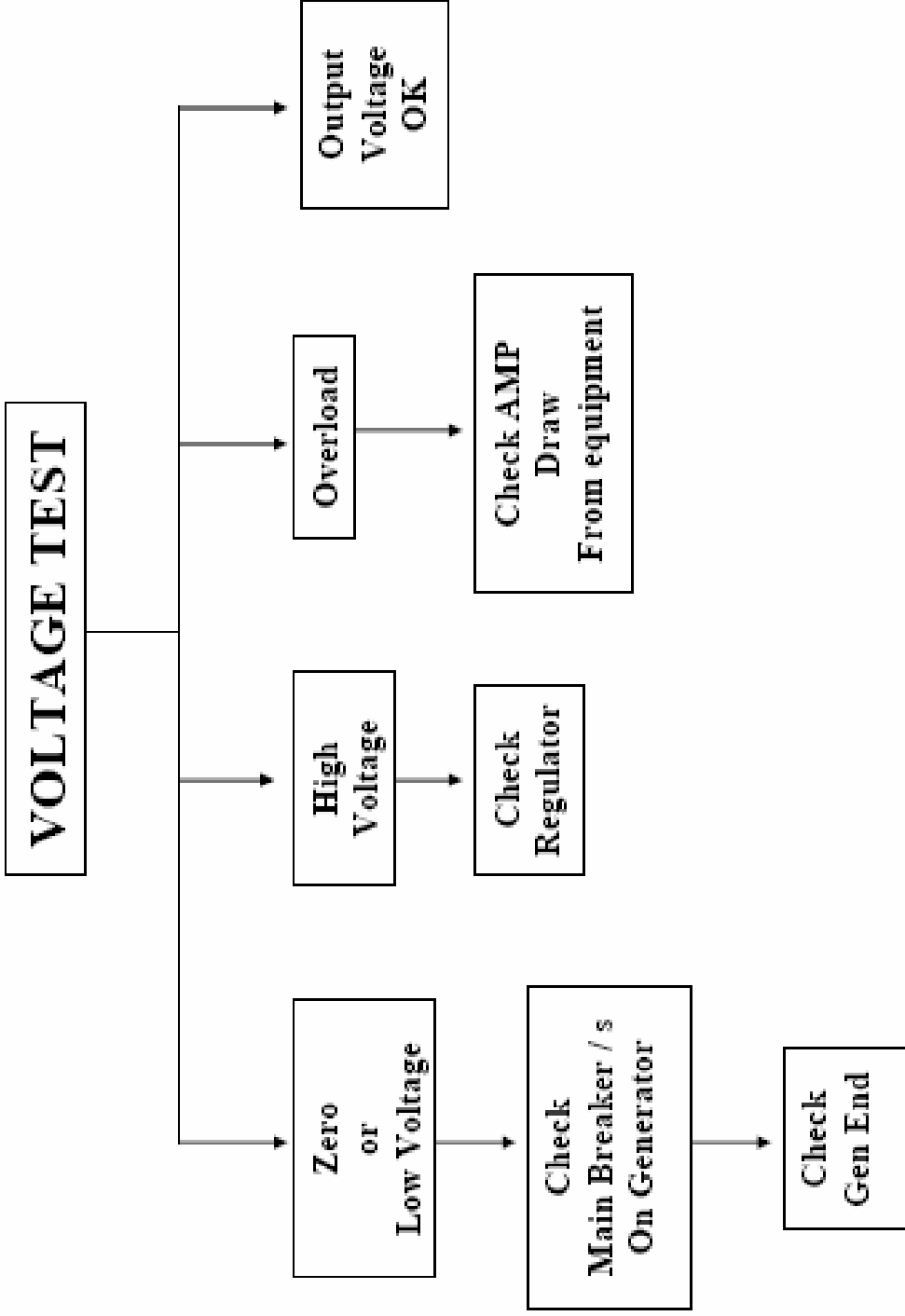

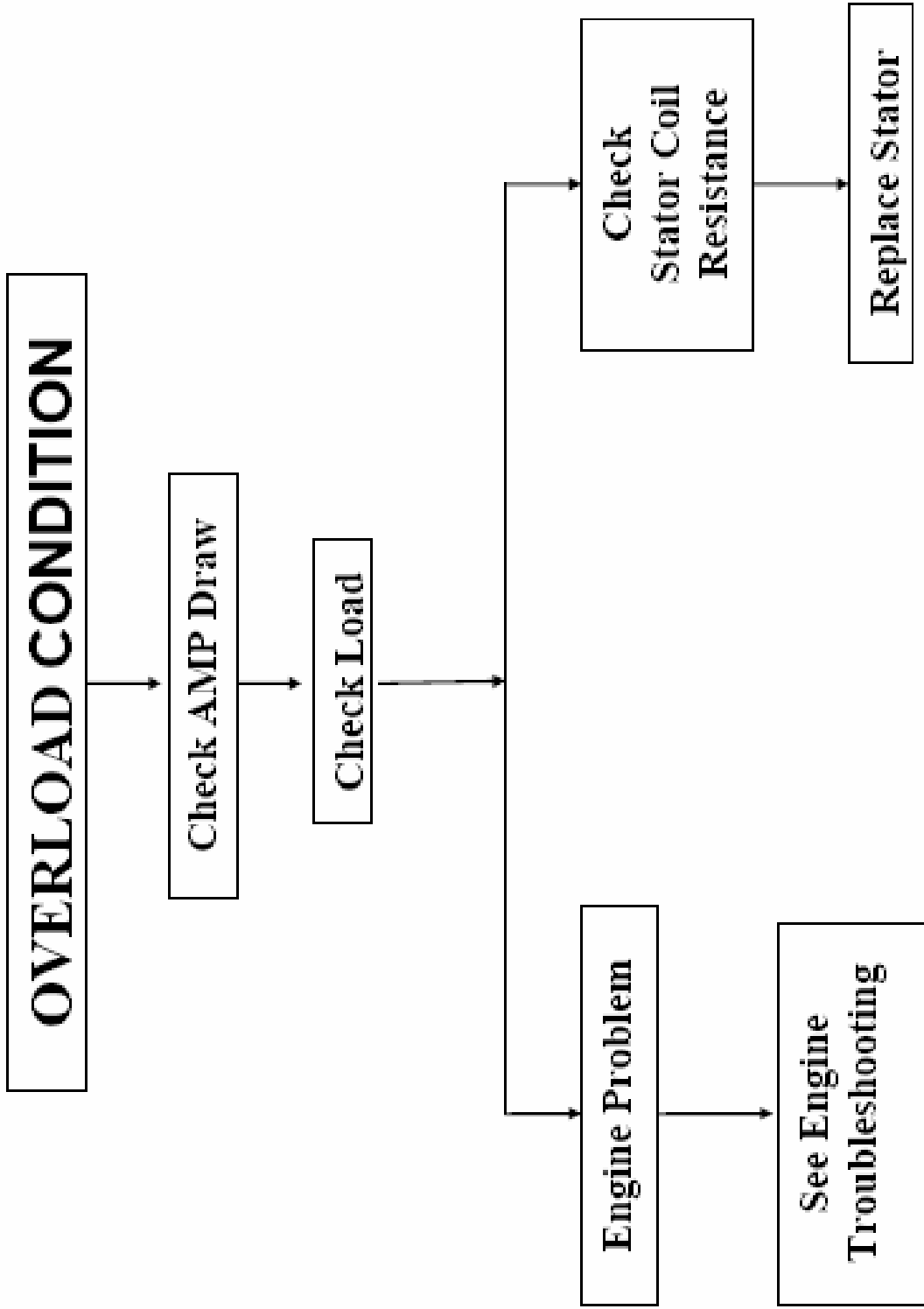

ENGINE TROUBLE SHOOTING

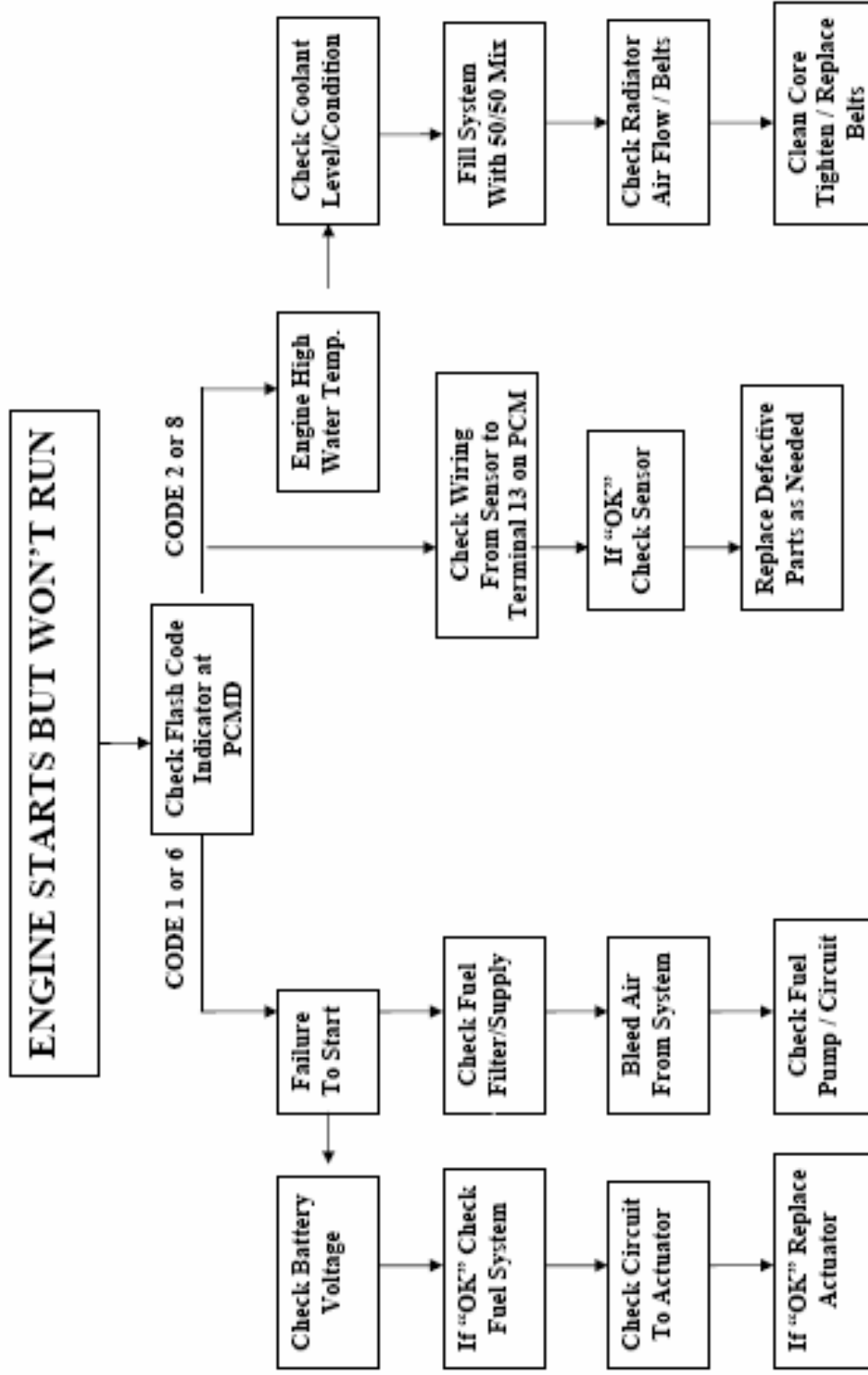

Technical Data

Connection Diagrams

SERIES HIGH WYE

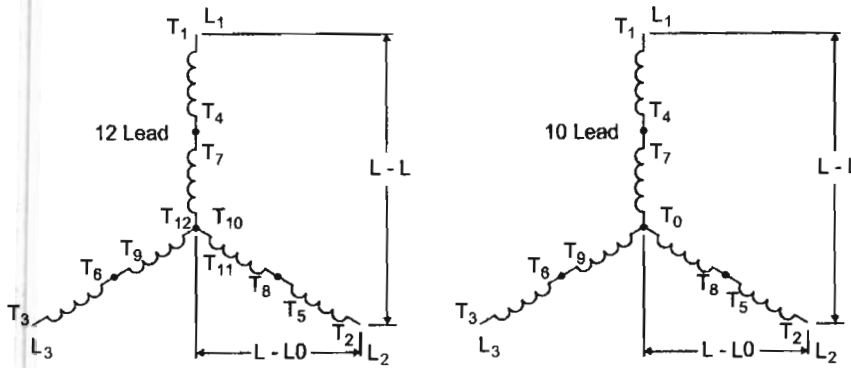

Voltage		
HZ	L-L	L-L0
60	380	219
	416	240
	440	254
	460	266
	480	277
50	380	219
	400	231
	415	240
	440	254

PARALLEL LOW WYE

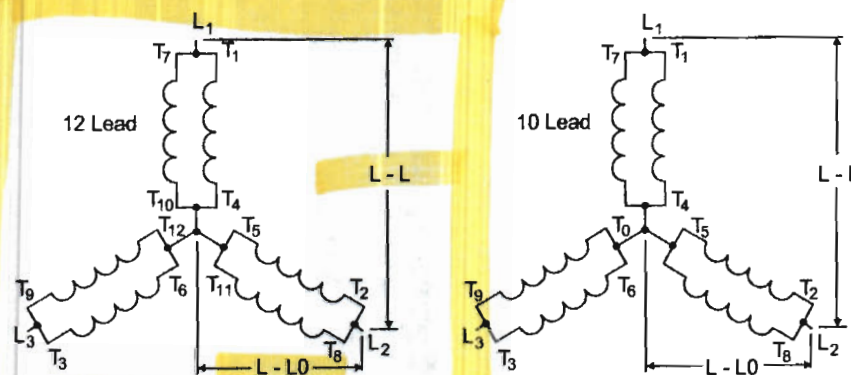

Voltage		
HZ	L-L	L-L0
60	190	110
	208	120
	220	127
	230	133
	240	139
50	190	110
	200	115
	208	120
	220	127

WYE

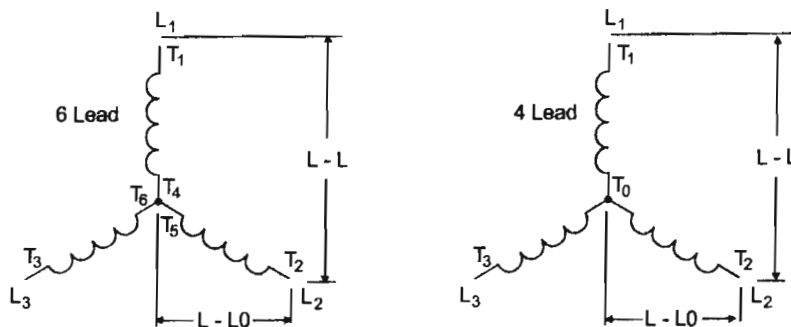

Voltage		
HZ	L-L	L-L0
60	380	219
	480	277
	600	346
	2400	1386
	3300	1905
	4160	2402
	6600	3811
	13800	7967
50	380	219
	400	231
	415	240
	3300	1905
	6600	3811
	11000	6351

SERIES HIGH DELTA

Voltage		
HZ	L-L	L-L0
60	240	120
	277	139
50	200	100
	220	110
	240	120

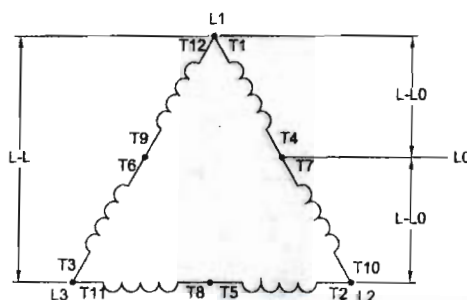

PARALLEL LOW DELTA

Voltage	
HZ	L-L
60	110
	120
50	100
	110

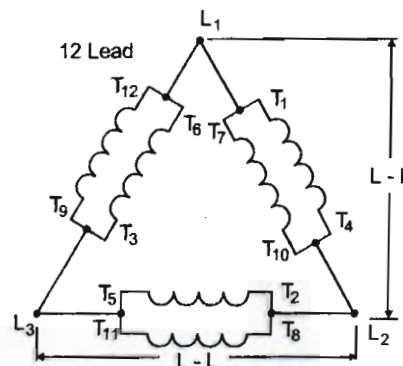

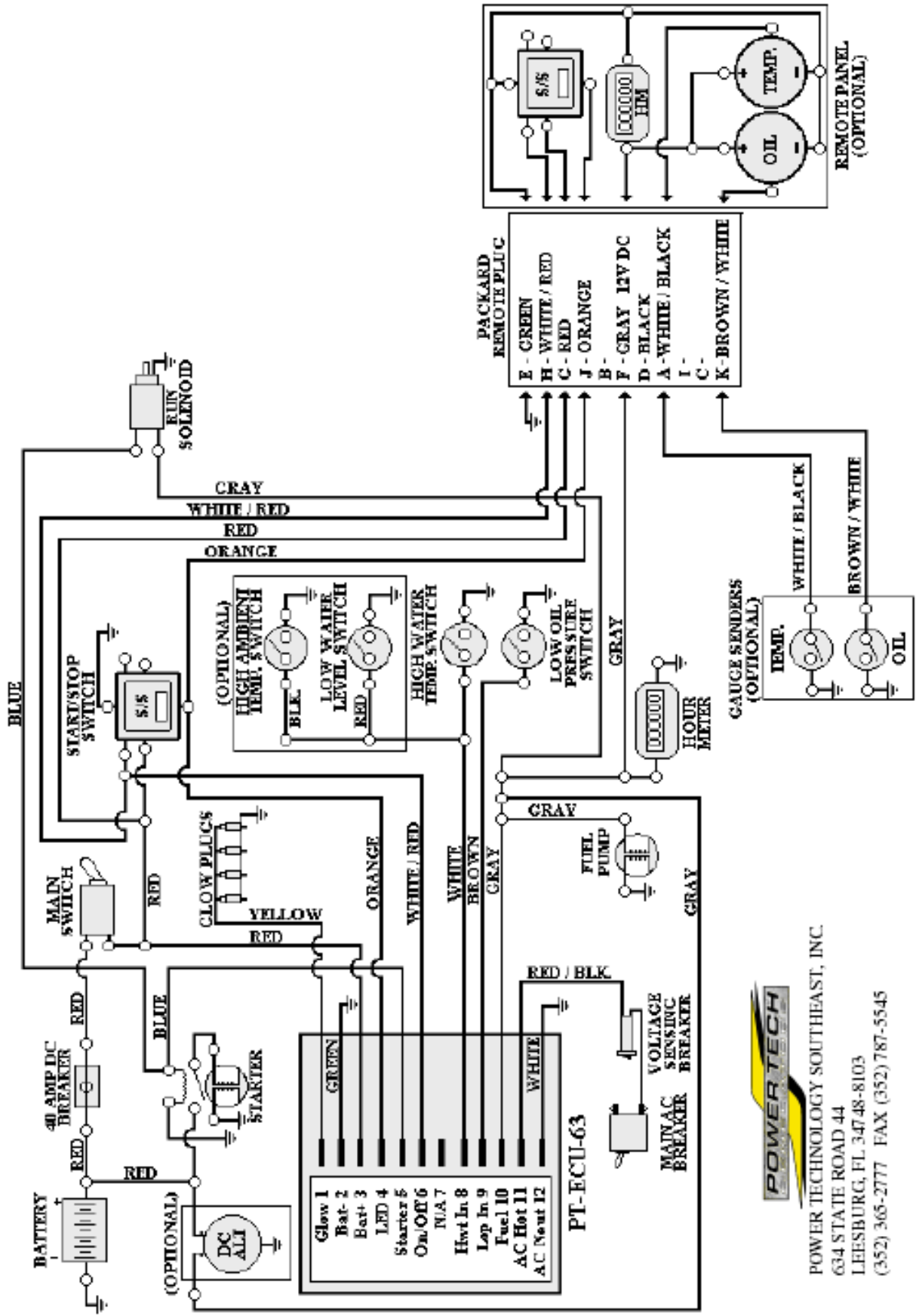

POWER TECHNOLOGY SOUTHEAST, INC.
 634 STATE ROAD 44
 LEESBURG, FL 34748-8103
 (352) 365-2777 FAX (352) 787-5545

12V DC ENGINE CONTROL
 PT-ECU-63