

Step by step installation guide

1. Remove trim

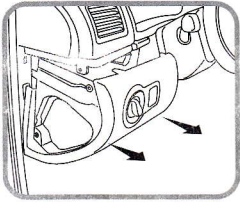

Remove trim from around the light switch

2. Connect wires

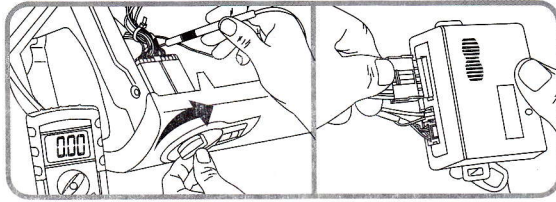

Connect all wires as per wiring diagram

Connect to ECU

3. Install ECU

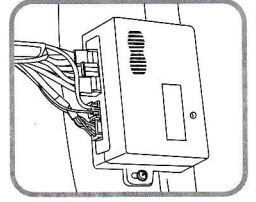

Fasten the ECU

4. Install the light sensor

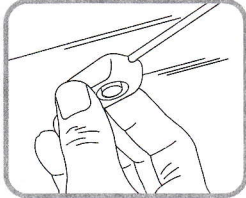

Fix the light sensor to the windscreen

When the handbrake wire is connected, the headlights will switch off and the side lights will remain on after the handbrake is applied

5. Connect handbrake wire

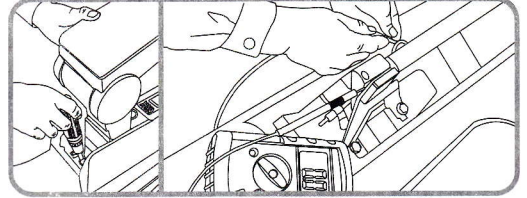

Connect the Black/White wire to handbrake wire

6. Function test

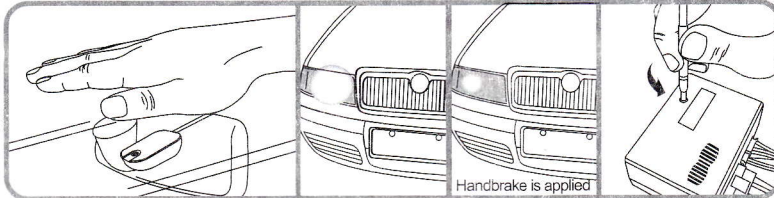

Perform the test when installation is complete

The sensitivity of the light sensor can be adjusted

7. Refit trim

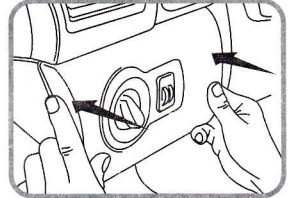

After completion, refit trim

Wiring diagram

The wiring diagram may vary due to different types of vehicles.

Negative wiring

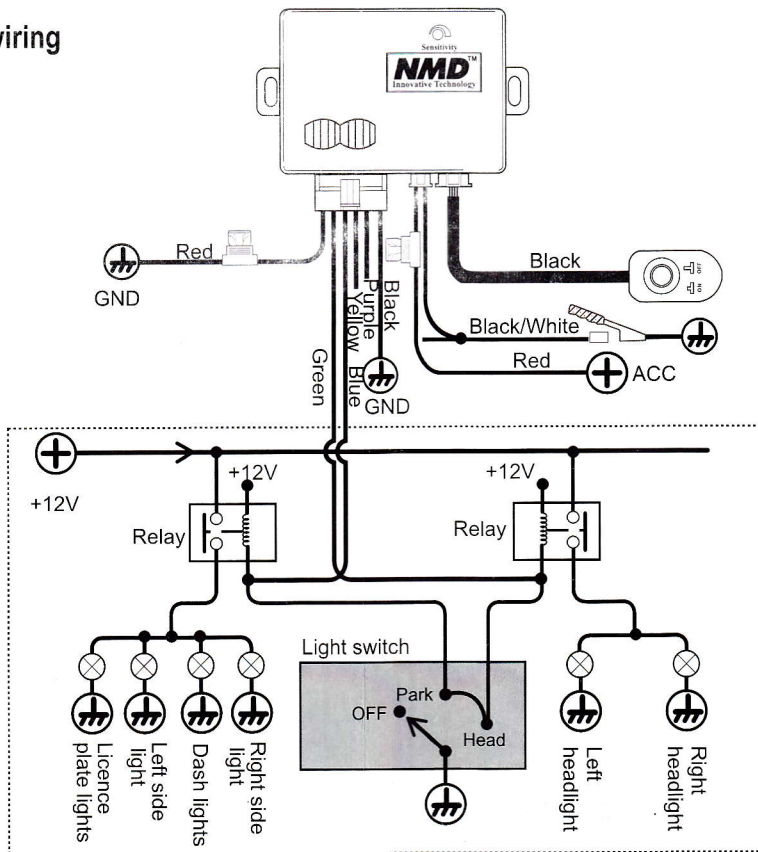

Insulate the yellow and purple wires if they are not connected