

IAME

Parilla

LEOPARD 125cc - RL - TaG - K engine



**ASSEMBLY INSTRUCTIONS
&
USER MANUAL**

INDEX

	Page
GENERAL DESCRIPTION OF THE ENGINE	1
CHARACTERISTICS OF THE "LEOPARD" ENGINE – OPERATIONAL LIMITS	2
1- Contents of the packing	2
2- Motor identification Number	4
3- Preparation and installation of the engine on the chassis	5
3.1 Installation sketch of the engine on the chassis	5
3.2 Install the water cooling system	6
3.3 Exhaust header assembly	10
3.4 Preparation and installation of the motor-mount	10
3.5 Install the carburetor	11
3.6 Install the engine on the chassis	13
3.7 Install the clutch cover with H.T. coil	14
3.8 Electrical connections	15
3.9 Installation of the intake silencer	20
3.10 Install the exhaust	21
4- Gasoline and Oil	22
5- Carburetor Adjustment guide	23
6- Starting and stopping the engine	24
7- Engine break-in	25
8- RPM limitation	25
9- Inlet silencer	25
10- Exhaust system	26
11- Centrifugal clutch	26
12- Instructions for the assembly/disassembly of the clutch	28
13- Battery	29
14- Warnings on the electrical system	30
15- Spark plug and thermal degree	31
16- Choice of the best sprocket ratio	32
17- Replacement of the starter brushes	35
18- Scheduled maintenance	41
19- Troubleshooting	42
20- Engine and accessories preservation	43
21- Fastener Torque Table	43
Wiring diagram	

GENERAL DESCRIPTION OF THE ENGINE

This engine of the "TaG" series (Touch and Go) has been expressly designed and developed for the powering of karts for hobby racing on closed tracks, destined for this specific purpose. When designing this new line of engines, the technical solutions already adopted for the high performance engines were used, in order to guarantee the highest reliability of components, when the operating limitations are respected.

The motor is a single cylinder using the two stroke principle.

The cylinder and the crankcase are in aluminium alloy.

The pressed in liner is made of centrifugated cast iron, fully machined to guarantee the best possible stability.

The head is separated from the cylinder and secured by studs.

The crankshaft is built and supported by two ball-bearings. The crankshaft is of steel alloy, hardened and tempered, as is the connecting rod which runs on roller bearings.

The digital ignition with capacitive discharge is fed by a magneto which generates the spark energy for the starting of the engine, supplies the advance timing through an integrated pick-up and recharges the battery.

The ignition includes a digital electronic unit (power-pack), the stator-rotor, the starter relay, the H.T. coil, a switch key assembly, and the wiring harness (with a 5A fuse) which connects the whole system.

The electronic box which controls the advance, the rev. limitation and the engine start/stop logic, integrates the voltage regulator and the ignition circuit.

The starter relay (Solid type SSR), protected from short-circuits, supplies the power for the electric starter and is controlled by the power pack.

An RPM limiter, integrated in the power pack, prevents the engine from exceeding 17000 RPM during use.

The spark is generated also without a battery; it is therefore possible, in case of emergency, to start the engine with an external starter unit.

With the starter key in "RUN" position, the starter activates a Bendix type gear which engages the starter ring assembled on the clutch.

The engine is provided with an automatic dry centrifugal clutch with low maintenance and with interchangeable sprocket.

The carburetor is a diaphragm Tillotson carburetor with integral fuel pump, filter and all position mounting capability.

The battery (12 V - 9Ah) is a sealed, no maintenance battery and is supplied already preassembled, in the battery support box which can be easily adapted to all existing chassis.

The exhaust, included in the supply, is already tuned for the best possible performance.

The engine is supplied with a kit which includes the radiator, the pump, water hoses and whatever necessary for the assembly on the kart.

CHARACTERISTICS OF THE "LEOPARD" ENGINE - OPERATIONAL LIMITS

The characteristics of the engine are the following :

- Cycle: OTTO / 2 stroke
- Original cubic capacity: 123.67 cc
- Original bore: 54.00 mm
- Max. theoretical bore: 54.28 mm
- Stroke: 54.00 mm
- Lubrication : Fuel / oil mix 6% (16:1)
- Induction: Reed valve
- Carburetor: Membrane , Tillotson
- Cooling : Water
- Ignition: Digital / with integrated rev. limiter
- Battery charge: With integral generator
- Electric start: 12V/0.30 Kw
- Clutch: Automatic, dry, centrifugal

Operational limits:

- **Max. RPM :** 17000 RPM (with rev. limiter)
- **Min. water Temperature:** 45°C
- **Max. water Temperature:** 65°C



ATTENTION:

Never exceed the above limits, no obligation of IAME exists in case the above limits are exceeded.

1- CONTENTS OF THE PACKING

Each Leopard engine is supplied with the accessories under shown:

EXHAUST SYSTEM	QuantitY
• Flexible	1
• Spring for flexible	3
• Exhaust fiber strip	1
• Exhaust manifold	1
• Exhaust muffler	1
INDUCTION	
• Tillotson carburetor	1
• Intake silencer	1
ELECTRICAL PLANT	
• Battery 12 V	1
• Battery support	1
• Battery strip	1
• Battery fixing clamps	2
• Electronic box (power-pack)	1
• Starter relay	1
• H.T. coil	1
• Starting key assembly	1
• Fixing clamps	8
• NGK BR 10 EG spark plug	1
• Spark plug cap	1
MISCELLANEOUS	
• Clutch cover	1
• Starter brushes kit (refill)	1
• Dual-Lock fixing strap	1
WATER COOLING SYSTEM	
• Radiator	1
• Radiator support kit	1
• Water hose kit	1
• Complete pump group	1

ACCESSORIES



EXHAUST SYSTEM



BATTERY WITH SUPPORT



NGK SPARK PLUG



COMPLETE ELECTRIC ASSEMBLY

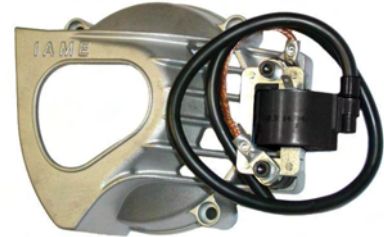

CLUTCH COVER / H.T. COIL



ADDITIONAL ENGINE PLATE



STARTER BRUSHES KIT



INTAKE SILENCER



TILLOTSON CARBURETOR



RADIATOR SUPPORT KIT



COMPLETE PUMP GROUP



WATER HOSE KIT



RADIATOR

2- MOTOR IDENTIFICATION NUMBER

The official motor identification number can be found stamped in the lower left part of the crankcase, next to the electric starter (see fig.) The number normally includes a letter followed by 4 digits (there can be exceptions in some special cases). Other numbers stamped on the crankcase or other surfaces of the motor refer to various manufacturing processes and do not identify the motor.

NOTE:

In case of need for spares and when contacting the IAME Support Centers, please always refer to the Motor Identification Number and to the motor model.

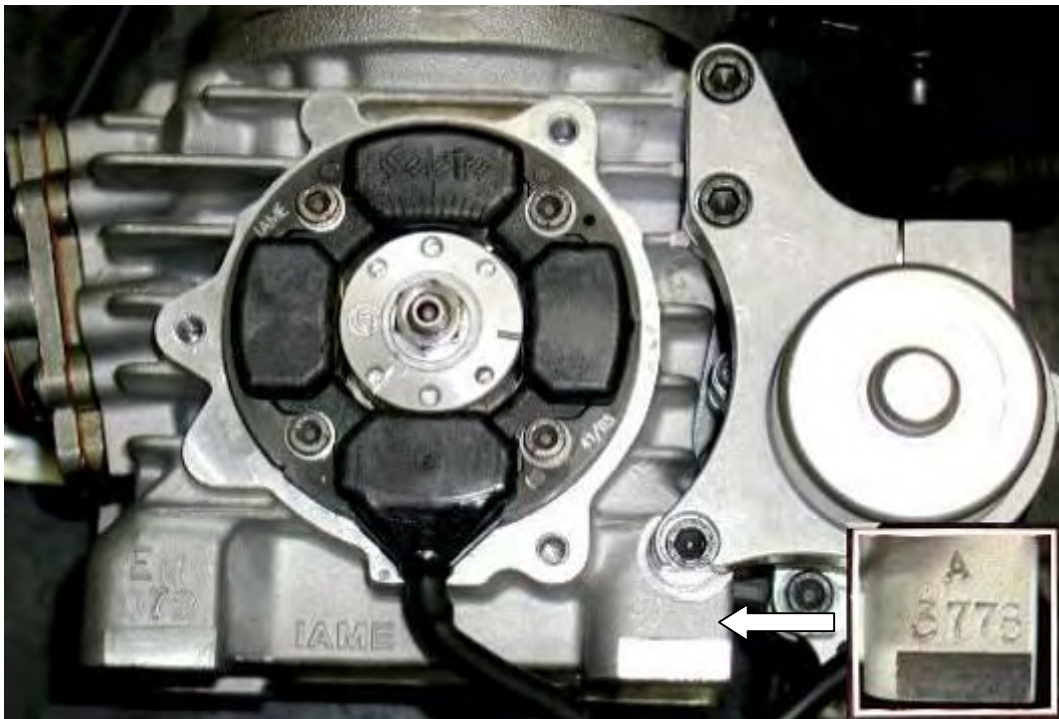

3- PREPARATION AND INSTALLATION OF THE ENGINE ON THE CHASSIS

NOTE:

In case the engine is supplied already assembled on the chassis, it is at care of the assembler to follow these instructions. The final customer, in this case, can skip this section and can start reading from section 4.

Whenever the engine or a component is disassembled, it is necessary to always follow the under shown instructions for proper reassembly.

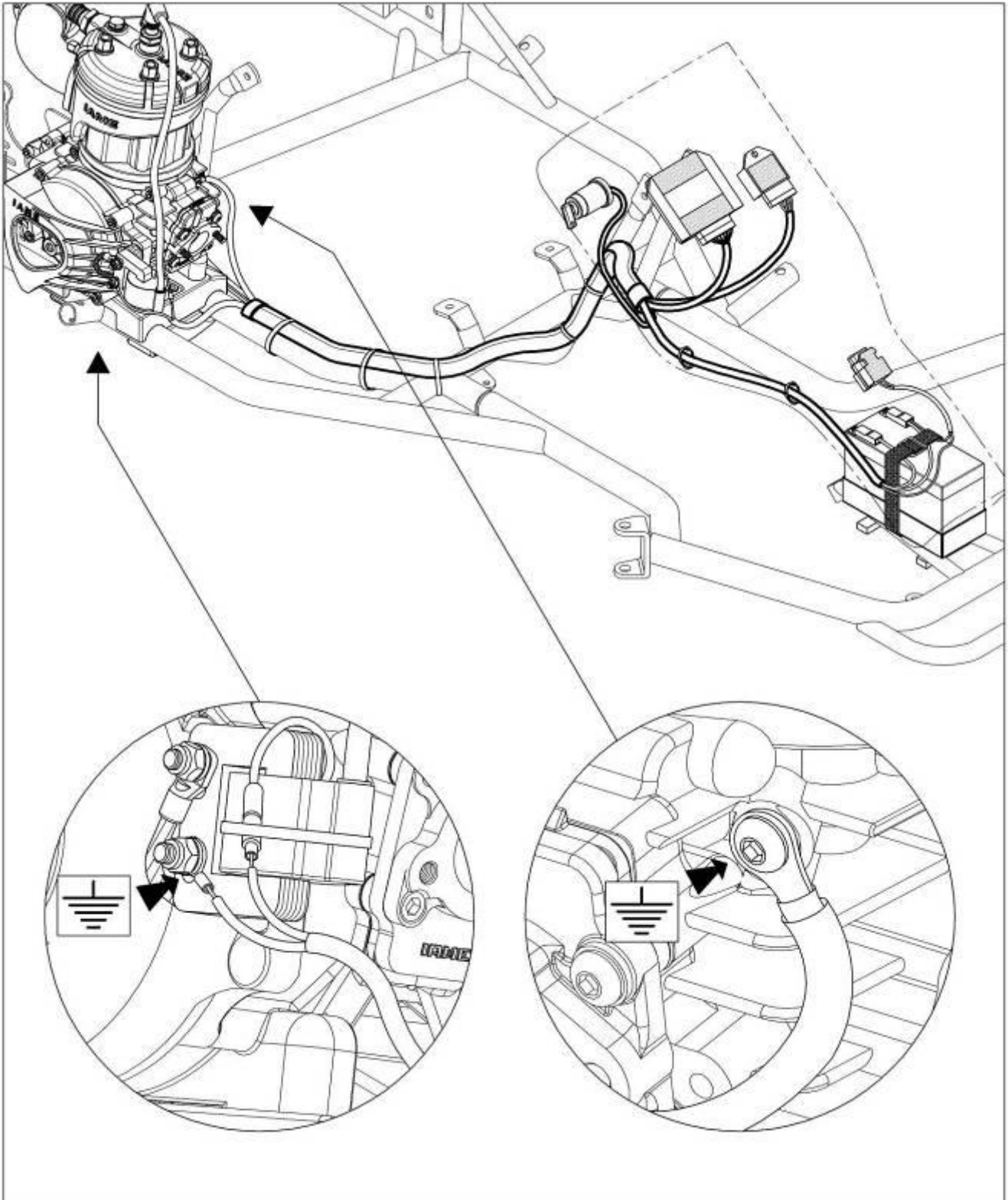

3.1- INSTALLATION SKETCH OF THE ENGINE ON THE CHASSIS



3.2- INSTALL THE WATER COOLING SYSTEM

NOTE:

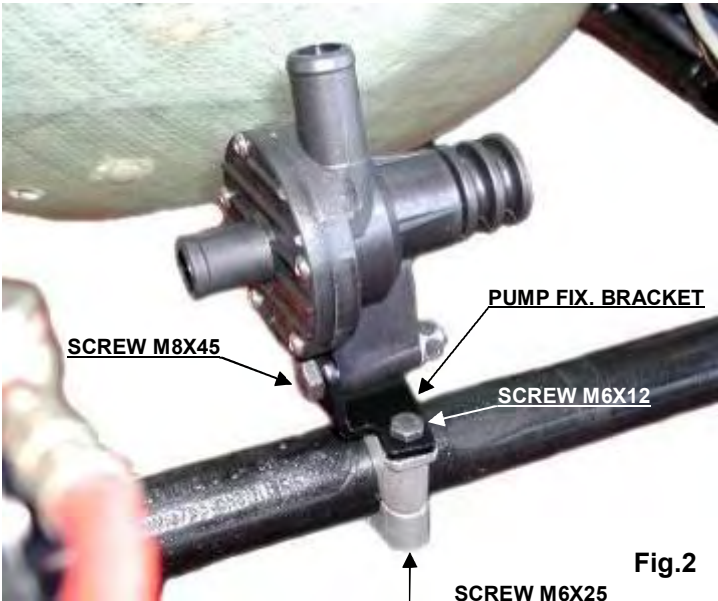
To install the water pump belts it is necessary to remove the rear axle.

<p>1</p>	<p>REINSTALL THE REAR AXLE AFTER HAVING INSERTED TWO BELTS SUGGESTION: INSTALL OTHER TWO BELTS AS SPARES AND FIX THEM WITH TAPE TO THE AXLE.</p>	<p>Fig.1</p> 
<p>2</p>	<p>INSTALL THE WATER PUMP (1 SCREW M8x45 WITH WASHER AND NUT) ON THE PUMP BRACKET ON THE REAR CROSS RAIL (SEE FIG. 1). TORQUE AT 18÷22 Nm (160÷190 in-lb)</p> <p>IN CASE THERE IS NO BRACKET FOR THIS PURPOSE IT IS NECESSARY TO INSTALL THE PUMP ON REMOVABLE CLAMPS AVAILABLE IN DIFFERENT DIAMETERS (∅28/30/32mm).</p> <p>ASSEMBLE THE PUMP FIXING BRACKET ON THE CLAMP (N°2 SCREWS M6x12) AND PLACE THE CLAMPS ON THE REAR CROSS RAIL (N°2 SCREWS M6x25). INSTALL THE PUMP ON THE BRACKET (N°1 SCREW M8x45 WITH WASHER AND NUT – SEE FIG. 2). TIGHTEN BY HAND THE SCREW ON THE PUMP LETTING IT FREE TO ROTATE FOR THE ALIGNMENT AND TENSIONING OF THE BELTS.</p>	 <p>Fig.2</p>
<p>3</p>	<p>INSTALL ON THE AXLE THE DRIVING PULLEY (N° 2 CLAMPS AVAILABLE IN DIFFERENT DIAMETERS ∅30/35/40/50mm) ALIGNING ITS RACE WITH THE DRIVEN PULLEY (SEE FIG.3). FIX THE TWO CLAMPS WITH 2 SCREWS M5x22 (TIGHTEN AT 6÷ 8 Nm) (50÷70 in-lb). TIGHTEN THE TWO SCREWS M6x25 ON THE PUMP FIXING CLAMPS AND THE SCREWS M6x12 ON THE PUMP FIXING BRACKET. TIGHTEN AT 8÷10 Nm (70÷90 in-lb)</p>	 <p>Fig.3</p>

<p>4</p>	<p>INSTALL THE BELTS AND TENSION (SEE FIG. 4). TIGHTEN THE SCREW M8x45 TORQUE AT 18÷22 Nm (160÷190 in-lb)</p>	 <p>Fig.4</p>
-----------------	---	---

BEFORE INSTALLING THE RADIATOR PREASSEMBLE THE FOLLOWING COMPONENTS

<p>5</p>	<p>INSERT THE 4 RUBBER DAMPENERS INTO THE FIXING HOLES ON THE RADIATOR (SEE FIG. 5).</p>	 <p>RUBBER DAMPENER</p> <p>Fig.5</p>
-----------------	--	---

<p>6</p> <p>- PLACE THE RADIATOR SUPPORT BRACKET BETWEEN THE RADIATOR FIXINGS BY TILTING ONE END AND INSERTING IT THROUGH THE RUBBER DAMPENERS (SEE FIG. 6)</p> <p><u>NOTE:</u> <u>OIL THE BRACKET ENDS AND THE DAMPENERS HOLES.</u></p>		 <p>RADIATOR SUPPORT BRACKET</p> <p>Fig.6</p>
--	--	---

- COMPLETE INSERTION OF THE RADIATOR SUPPORT BRACKET IN THE RUBBER DAMPENERS (SEE FIG. 7 AND 8).

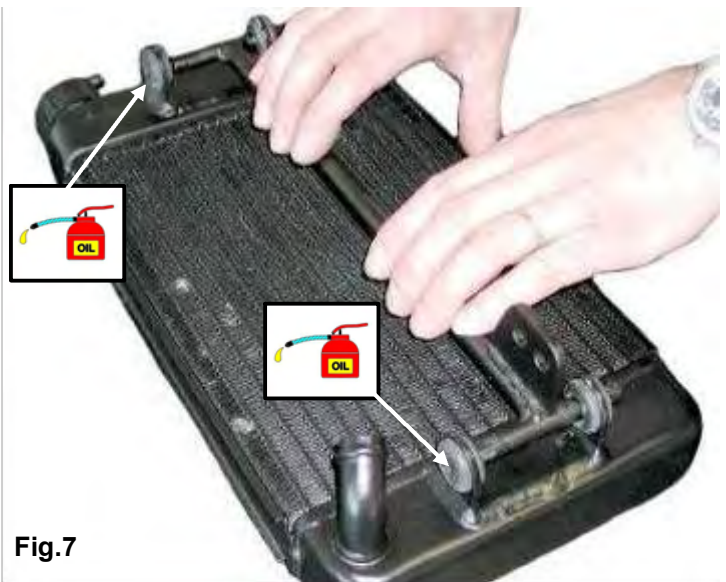

Fig.7



Fig.8

7

FIX THE RADIATOR SUPPORT BRACKET INSERTING ALSO THE RADIATOR FIXING BRACKET (RADIATOR CAP SIDE - N°1 SCREW M6x90 AND N°1 SCREW M6x85 WITH NUT).
 INSTALL THE "L" SHAPE BRACKET ON THE LOWER RADIATOR CLAMP (AVAILABLE IN DIFFERENT DIAMETERS Ø28/30/32mm - 2 SCREWS M6x12) AND FIX IT TO THE TONGUE ON THE RADIATOR SUPPORT BRACKET (N°1 SCREW M8x20 WITH NUT - SEE FIG. 9).

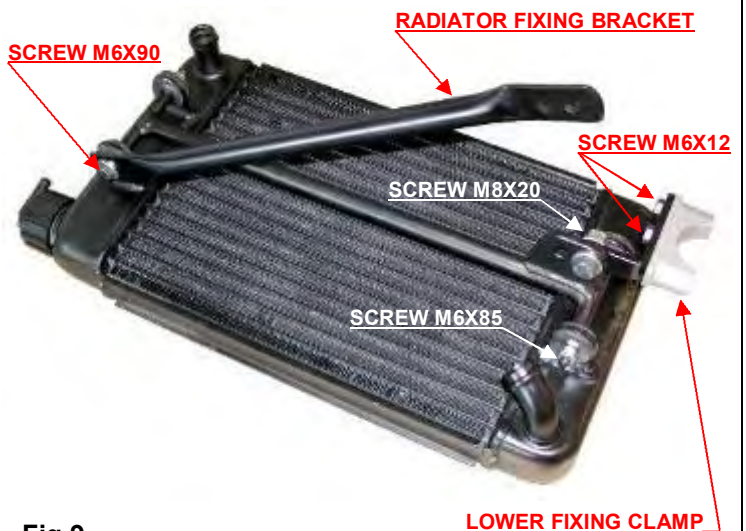





Fig.9

<p>8</p>	<p>PLACE THE RADIATOR FIXING CLAMP ON THE CHASSIS SIDE RAIL (BRAKE SIDE) (N°2 SCREWS M6x25). TIGHTEN THE BOLTS BY HAND (SEE FIG. 10).</p>	 <p>Fig.10</p>
<p>9</p>	<p>PLACE THE RADIATOR SO THAT THE HOLE ON THE RADIATOR BRACKET AND ONE OF THE UPPER HOLES ON THE BEARING SUPPORT BOX, MATCH. (N°1 SCREW M8) – (SEE FIG. 11). ONCE YOU FIND THE CORRECT POSITION TIGHTEN, THE M6x25 SCREWS ON THE CLAMP. TIGHTEN AT 8÷10 Nm (70÷90 in-lb)</p>	 <p>Fig.11</p>
<p>10</p>	<p>THE KIT INCLUDES THREE RUBBER HOSES.</p> <ul style="list-style-type: none"> - CONNECT THE FIRST HOSE TO THE FITTING ON THE RADIATOR INLET AND THE FITTING ON THE ENGINE OUTLET. <u>TIGHTEN WITH STEEL CLAMPS ON BOTH SIDES.</u> - CONNECT THE SECOND HOSE TO THE FITTINGS ON THE RADIATOR OUTLET AND THE PUMP INLET, <u>TIGHTEN WITH STEEL CLAMPS ON BOTH SIDES.</u> - CONNECT THE THIRD HOSE TO THE FITTINGS ON THE PUMP OUTLET AND THE ENGINE INLET, <u>TIGHTEN WITH STEEL CLAMPS ON BOTH SIDES.</u> (SEE FIG. 12). 	 <p>Fig.12</p>

BEFORE STARTING THE ENGINE FOLLOW THESE RECOMMENDATIONS:

- Unscrew the cap on the radiator and loosen the breather plug on the engine head.
- Fill the radiator until the water comes out from the plug on the head (there is no air in the system now) and the radiator is completely filled. Tighten the cap (the system contains appr. 1 lt. of water).
- **It is advisable to put a small cup to recover water from the breather on the cap in case of boiling water.**
- **After the engine run-in, check the water level in the radiator and top up if necessary.**

<p>3.3 EXHAUST HEADER ASSEMBLY NOTE: THE ENGINE IS SUPPLIED WITH THE EXHAUST GASKET AND NUTS ALREADY INSERTED. WHEN THE SHIPMENT IS MADE AN EXHAUST COVER GASKET IS PROVIDED TO PROTECT THE INTERNAL PARTS.</p>	
<p>3.3.1 REMOVE THE NUTS AND THE EXHAUST COVER.</p>	
<p>3.3.2 MAKE SURE THE EXHAUST GASKET IS IN SEAT AND INSTALL THE EXHAUST HEADER (SEE FIG 1).</p>	
<p>3.3.3 INSTALL THE THREE WASHERS</p>	
<p>3.3.4 INSTALL THE THREE NUTS. TORQUE AT 9 ÷ 11 Nm (80 ÷ 100 in-lb)</p>	<p>12 POINT WRENCH 10 mm (OR OPEN WRENCH 10 mm)</p>

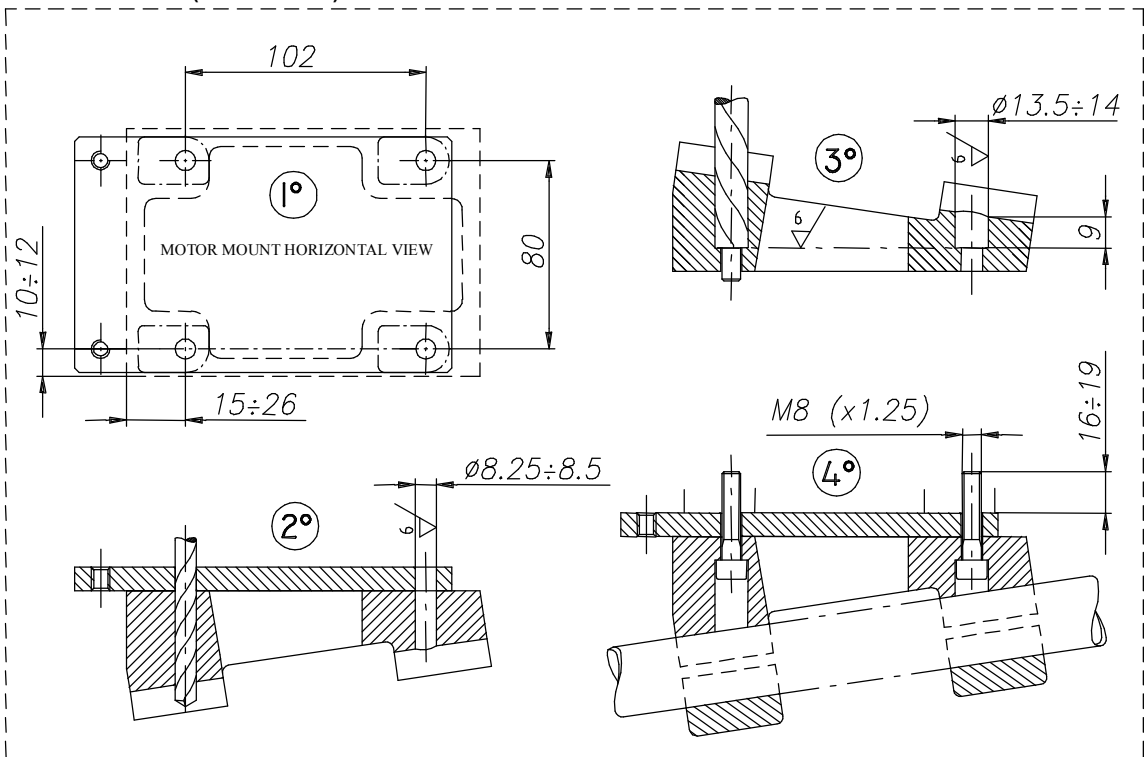
<p>3.4 PREPARATION AND INSTALLATION OF THE MOTOR-MOUNT NOTE: ALL THE DIMENSIONS ARE IN MILLIMETERS</p>
<p>3.4.1 DRILL 4 HOLES (DIAM. 8.5mm) IN THE MOTOR-MOUNT</p> 

3.4.2 BEFORE INSTALLING THE MOTOR MOUNT, POSITION THE ADDITIONAL MOUNT PLATE ON THE CRANKCASE (SEE FIG. 2).



3.4.3 INSTALL THE MOTOR MOUNT. MAKE SURE TO USE M8 ALLEN SCREWS WITH A LENGTH SUCH AS TO ENGAGE, IN THE CRANKCASE, A THREADED PORTION LENGTH OF 16÷19mm (THE SCREW MUST PROTRUDE FROM THE PLATE FOR 16÷19mm) (SEE FIG. 3 AND DRAW. PAG. 10)

6 mm. ALLEN WRENCH

4 ALLEN SCREWS M8 – TORQUE AT 22÷24 Nm (190 ÷ 210 in-lb)



3.5 INSTALL THE CARBURETOR

3.5.1 INSTALL THE GAS CABLE CLAMP ON THE SUPPORT (SEE FIG. 4)

12 POINT WRENCH 10mm



3.5.2 REMOVE 2 SCREWS 3.5mm ON THE CARB. PUMP (IN CORRESPONDENCE OF THE THROTTLE LEVER) (SEE FIG. 5).

SCREWDRIVER 4.8 mm.

Fig.5

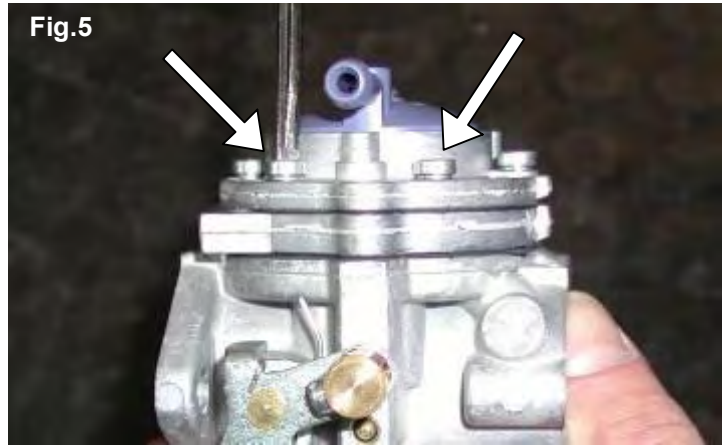

3.5.3 INSERT THE GAS BRACKET AND THE TWO SCREWS (SEE FIG. 6).

Fig.6



3.5.4 INSTALL THE INTAKE SUPPORT – 2 SCREWS M5 X10 (SEE FIG. 7)

ALLEN WRENCH 3 mm

Fig.7



3.5.5 INSTALL THE CARBURETOR (SEE FIG. 8 / 9).

- REMOVE THE TWO M6 NUTS FROM THE INLET MANIFOLD.
- REMOVE THE PLASTIC PLUG FROM THE INLET MANIFOLD.

⚠ ATTENTION:
MAKE SURE THAT THE PRESSURE HOLE ON THE GASKET IS NOT PLUGGED.

10 mm OPEN WRENCH

Fig.8

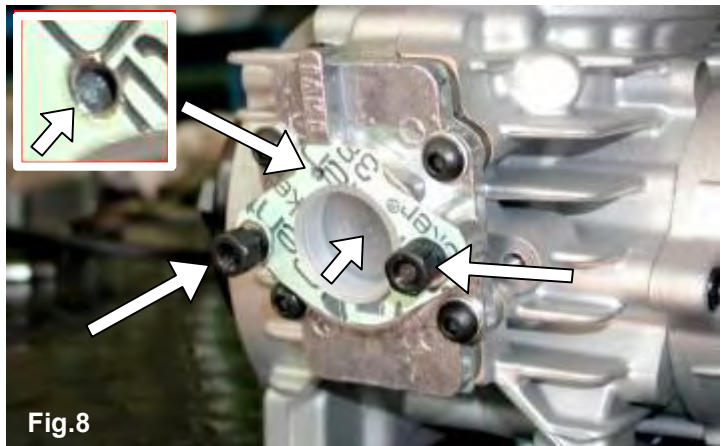



ATTENTION:
WHEN REPLACING THE CARB. GASKET ALWAYS MAKE SURE THAT THE GASKET IS INSTALLED SO THAT THE HOLE IN THE GASKET MATCHES WITH THE TWO PRESSURE HOLES IN THE CARB. AND IN THE CRANKCASE: OTHERWISE THE ENGINE WON'T START.

INSTALL THE CARBURETOR.
N.2 NUTS M6 AND TWO WASHERS.
TORQUE AT $6 \div 10$ Nm ($50 \div 90$ in-lb)



Fig.9

3.6 INSTALL THE ENGINE ON THE CHASSIS

3.6.1 POSITION THE ENGINE ON THE 2 OUTSIDE MAIN RAILS AND FIX THE MOTOR-MOUNT WITH THE TWO CLAMPS (SEE FIG.10)

SUGGESTION:
NEVER TORQUE COMPLETELY THE CLAMPS UNTIL THE CHAIN IS INSTALLED AND PROPERLY ALIGNED.



Fig.10

3.6.2 CHECK THE ALIGNMENT OF THE ENGINE SPROCKET AND THE AXLE SPROCKET WITH A STRAIGHT EDGE (SEE FIG. 11).

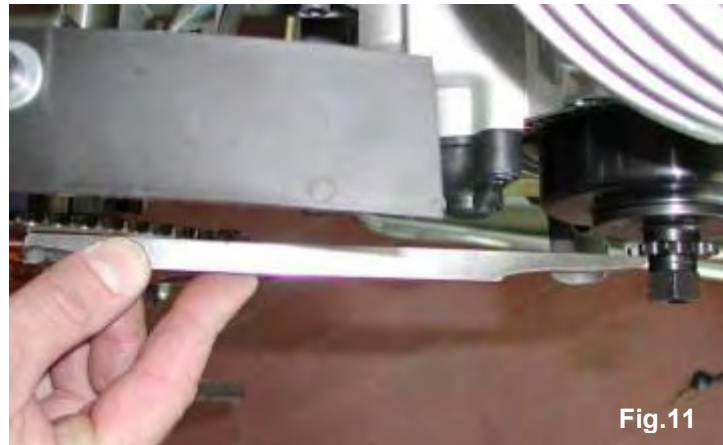

Fig.11

3.6.3 INSTALL THE CHAIN (PITCH: 7.775) (SEE FIG. 12).

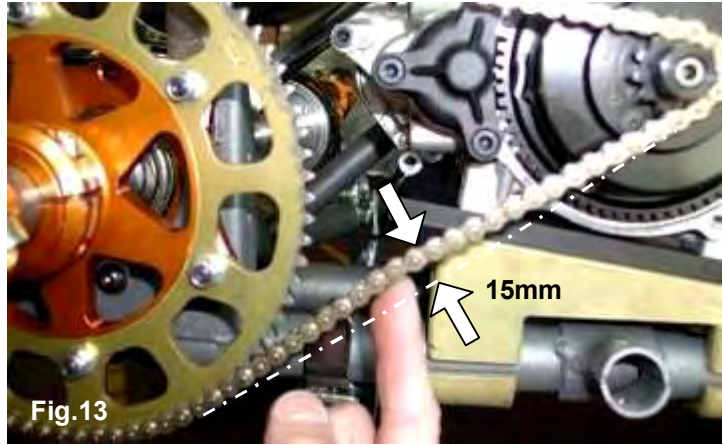

Fig.12

3.6.4 MOVE THE ENGINE ON THE RAILS AND OPTIMIZE THE CHAIN TENSION .



ATTENTION:
THE PLAY OF THE CHAIN MUST BE APPR. 15mm (½±¼ inch) MEASURED IN THE SHOWN POINT (SEE FIG. 13)



3.6.5 TORQUE THE CLAMP SCREWS

3.7 INSTALL THE CLUTCH COVER WITH H.T. COIL

REMOVE THE 3 SCREWS M6 X 30 ON THE CRANKCASE (SEE FIG. 14) AND INSTALL THE CLUTCH COVER WITH H.T. COIL (SEE FIG.15).

TORQUE THE 3 SCREWS AT 8 ÷ 10 Nm (70 ÷ 90 in-lb)



ATTENTION:
ALWAYS MAKE SURE THAT THE GROUND CABLE ALWAYS CONNECTS THE COIL WITH THE ENGINE. AN INADEQUATE GROUNDING COULD DAMAGE THE IGNITION BEYOND REPAIR.

THE POSITION OF THE H.T. COIL HAS BEEN CHOSEN TO BE AS FAR AS POSSIBLE FROM THE EXHAUST AS THE EXCESSIVE HEAT COULD DAMAGE THE COIL BEYOND REPAIR.

5 mm ALLEN

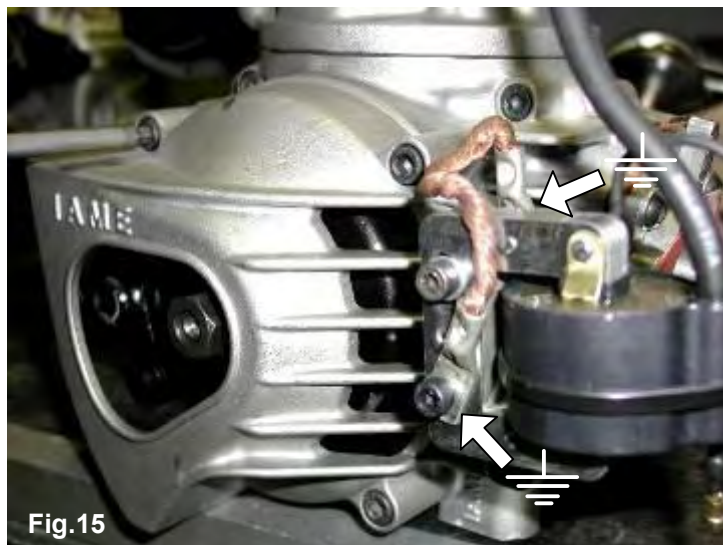
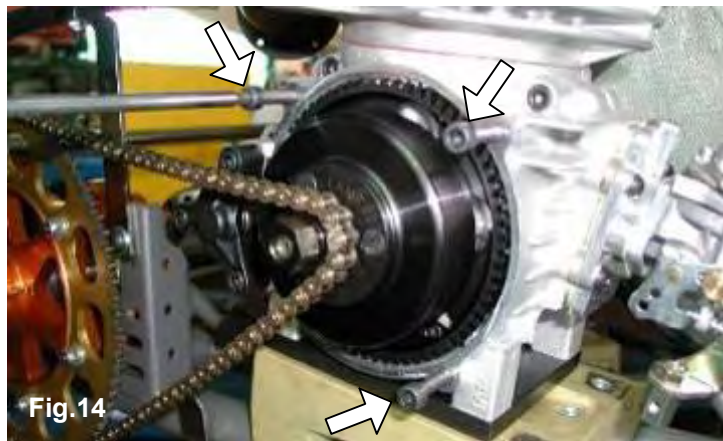

3.8

ELECTRICAL CONNECTIONS
(Refer to the attached electrical schematic).

NOTE:
For a correct installation follow the under shown instructions.

Fig.16



3.8.1 INSERT THE BATTERY STRAP IN THE BATTERY SUPPORT (SEE FIG. 16).

3.8.2 PLACE THE BATTERY SUPPORT BOX IN THE FRONT OF THE CHASSIS (UNDER THE FRONT FAIRING) AND FIX IT WITH THE CLAMPS TO THE LOWER STEERING COLUMN SUPPORT TUBES (M6x25 SCREWS- SEE FIG. 17).
TORQUE AT 8 ÷ 10 Nm (70÷ 90 in-lb)
THE SUPPORT BOX MUST BE FIXED WITH AT LEAST ONE BOLT FOR EACH CLAMP. FIX THE BOX WITH MORE THAN ONE BOLT DEPENDING ON THE TYPE OF CHASSIS.

10mm BOX WRENCH

Fig.17



NOTE:
THE BOX AND CLAMPS ARE PROVIDED WITH VARIOUS HOLES WHICH ALLOW INSTALLATION ON ALL KIND OF CHASSIS.

3.8.3 INSERT THE BATTERY IN THE BOX AND FASTEN WITH THE BATTERY STRAP (SEE FIG. 18).
POSITION THE BATTERY TERMINALS AS SHOWN ON THE FIGURE.



⚠ ATTENTION:
PAY ATTENTION NOT TO SHORT-CIRCUIT THE BATTERY TERMINALS AS THE BATTERY COULD BE DAMAGED BEYOND REPAIR.

Fig.18

3.8.4 POSITION THE WIRING HARNESS STARTING FROM THE ENGINE AND ALONG THE RAIL, THE STEERING COLUMN AND UNDER THE FRONT PANEL FAIRING (SEE FIG. 19).
TIGHTEN WITH PLASTIC CLAMPS.



Fig.19

⚠ ATTENTION:
NEVER LET THE HARNESS GET IN TOUCH WITH THE GROUND OR WITH ROTATING PARTS AS IT COULD BE DAMAGED BEYOND REPAIR.

3.8.5 –CONNECT THE TERMINAL FROM THE IGNITION WITH THE 8 POLE TERMINAL ON THE HARNESS SEE FIG. 20).

-CONNECT THE ONE WAY TERMINAL FROM THE ELECTRIC STARTER WITH THE ONE WAY TERMINAL ON THE HARNESS (SEE FIG. 21).



ATTENTION:
MAKE SURE THAT THE FIXING TONGUES ARE PROPERLY INSERTED TO GUARANTEE THE BEST POSSIBLE CONNECTION OF THE TERMINALS.

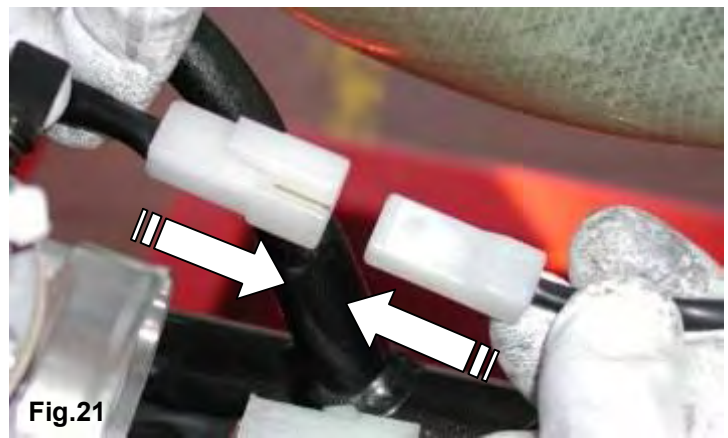

3.8.6 CHECK THE ELECTRIC STARTER CABLE FIXING (SEE FIG. 22) AND COMPLETE THE FIXING OF THE HARNESS (SEE FIG. 23).



ATTENTION:
NEVER LET THE HARNESS GET IN TOUCH WITH THE GROUND OR WITH A ROTATING PART AS IT COULD BE DAMAGED BEYOND REPAIR.

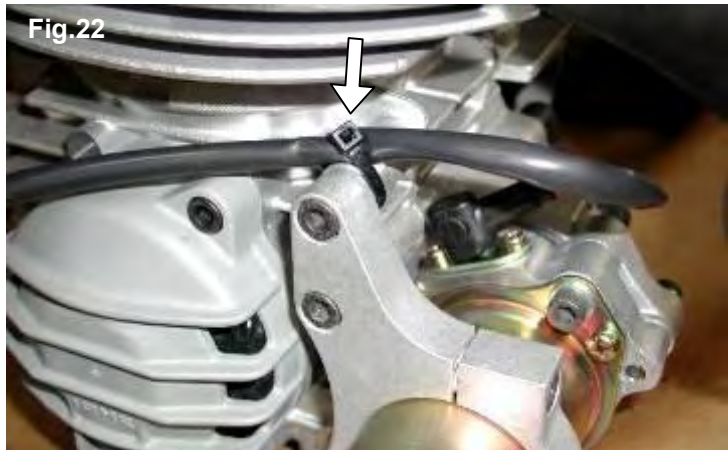

3.8.7 FIX THE HARNESS GROUND CABLE WITH THE EYELET TERMINAL (Ø 6.5mm), ON THE ENGINE CRANKCASE, BY MEANS OF THE PROPER THREADED HOLE (SEE FIG. 24).
M6x12 SCREW

TORQUE AT 8 ÷ 10 Nm (70 ÷90 in-lb)



ATTENTION:
THIS OPERATION IS EXTREMELY IMPORTANT AS AN UNCERTAIN GROUNDING COULD DAMAGE THE POWER-PACK BEYOND REPAIR.

5 mm ALLEN

Fig.24

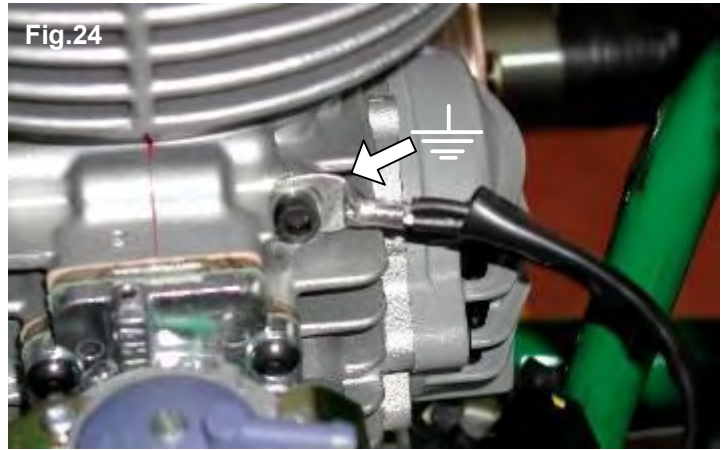

3.8.8 FIX THE EYELET TERMINAL (Ø 7mm), OF THE SECOND GROUND CABLE IN THE HARNESS (CLOSE TO THE COIL CABLE) TO THE H.T. COIL BY MEANS OF THE M6 NUT FIXING THE COIL (SEE FIG. 25).

TORQUE AT 8 ÷ 10 Nm (70 ÷90 in-lb)



ATTENTION:
THIS OPERATION IS EXTREMELY IMPORTANT AS AN UNCERTAIN GROUNDING COULD DAMAGE THE POWER PACK BEYOND REPAIR.

10mm BOX WRENCH

Fig.25



3.8.9 CONNECT THE H.T. COIL CABLE TO THE HARNESS TERMINAL (SEE FIG. 26).



ATTENTION:
FASTEN THE COIL CABLE WITH A PLASTIC CLAMP TO AVOID THAT EVENTUAL VIBRATIONS MIGHT DISCONNECT THE TERMINALS (SEE FIG. 27).

Fig.26

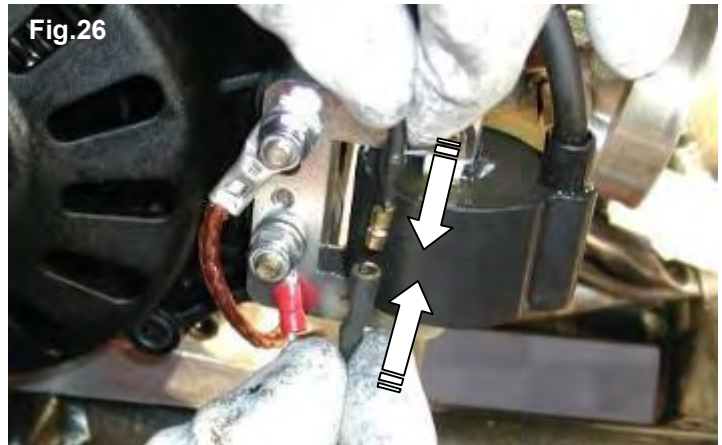

Fig.27



3.8.10 CUT THE DUAL-LOCK FIXING STRAP AND ATTACH IT TO THE ELECTRONIC BOX, THE STARTER RELAY, AND THE FUSE HOLDER (SEE FIG.28).

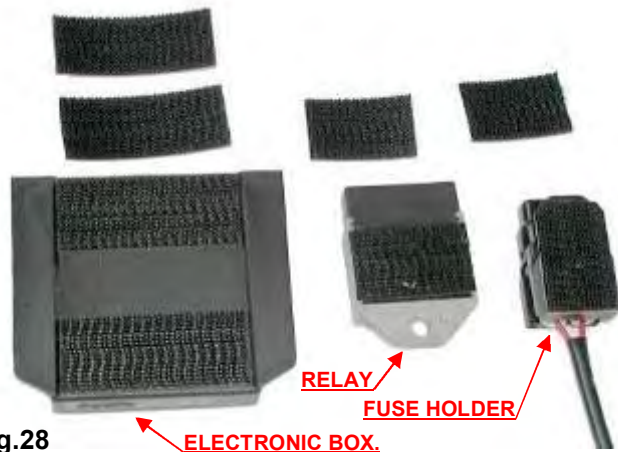

Fig.28

3.8.11 -CONNECT THE ELECTRONIC BOX TO THE 20 POLE TERMINAL IN THE WIRING HARNESS (SEE FIG. 29).

-CONNECT THE STARTER RELAY TO THE 4 POLE TERMINAL IN THE WIRING HARNESS (SEE FIG. 30).

⚠ ATTENTION:
MAKE SURE THAT THE FIXING TONGUES ARE PROPERLY INSERTED TO GUARANTEE THE BEST POSSIBLE CONNECTION OF THE TERMINALS.

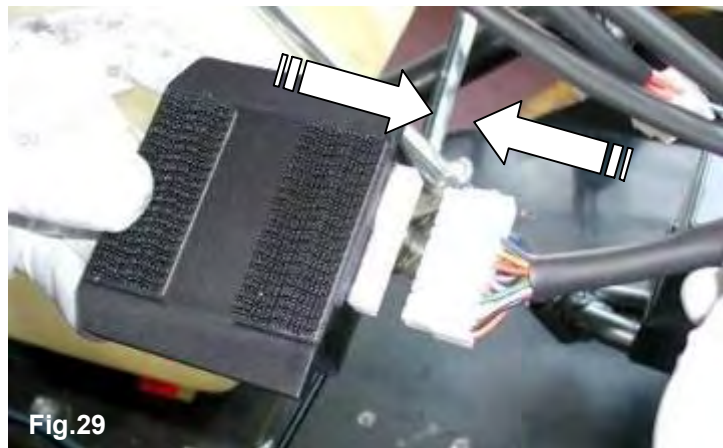

Fig.29

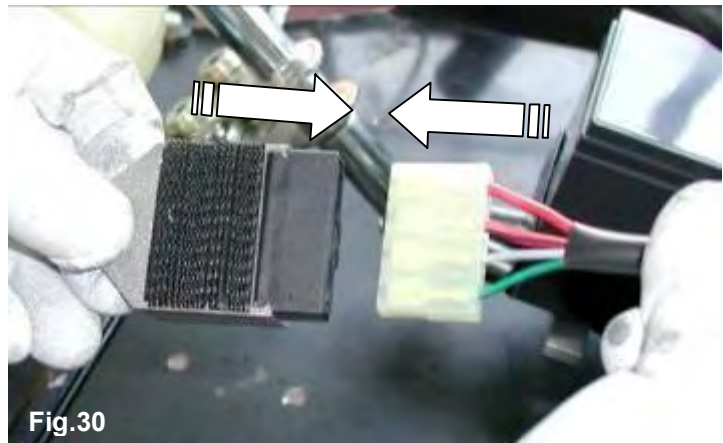

Fig.30

3.8.12 DRILL A Ø 22mm HOLE IN THE SIDE OF FRONT FAIRING (ENGINE SIDE) AND INSERT THE STARTING ASSEMBLY (SEE FIG. 31). SECURE THE ASSEMBLY WITH THE THREADED RING NUT.

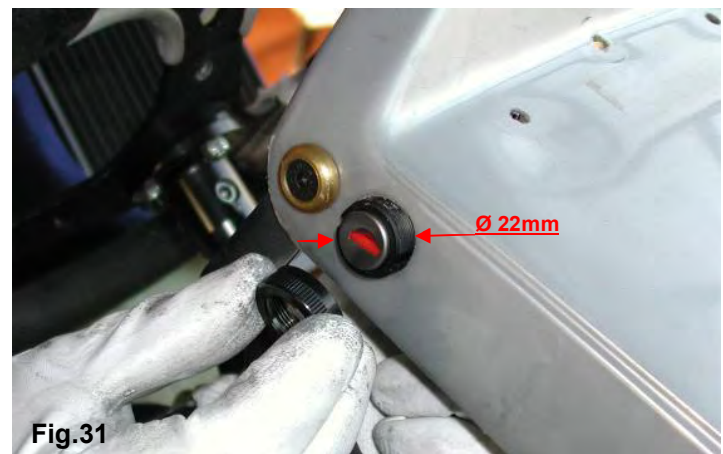

Fig.31

3.8.13 CONNECT THE CABLE FROM THE STARTING ASSEMBLY WITH THE 8 POLE TERMINAL IN THE WIRING HARNESS (SEE FIG. 32).



ATTENTION:
MAKE SURE THAT THE FIXING TONGUES ARE PROPERLY INSERTED TO GUARANTEE THE BEST POSSIBLE CONNECTION OF THE TERMINALS.

Fig.32

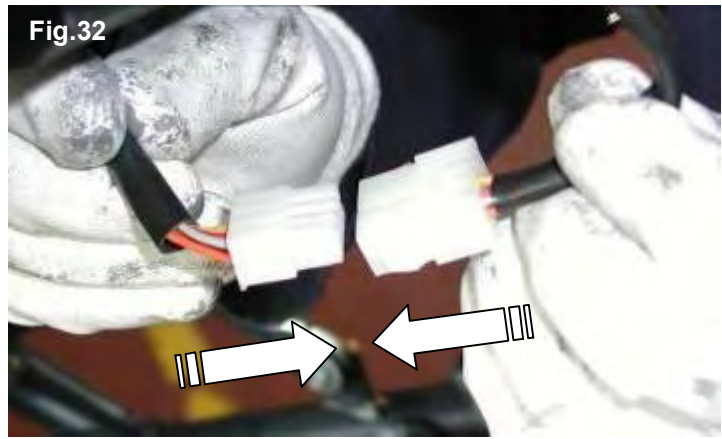

3.8.14 ATTACH THE DUAL LOCK FIXING STRAP (CLOSE TO THE STEERING COLUMN) AND PLACE THE ELECTRONIC BOX AND THE STARTER RELAY (SEE FIG. 33).

NOTE:
CLEAN AND DEGREASE THE FAIRING FIXING SURFACE WHERE THE STRAP IS TO BE PLACED TO GUARANTEE THE BEST POSSIBLE STRAP ATTACHMENT.

Fig.33



3.8.15 DRILL A FEW HOLES IN THE FAIRING TO ATTACH THE CABLES WITH PLASTIC CLAMPS (SEE FIG. 34).

Fig.34



3.8.16 ATTACH THE DUAL LOCK FIXING STRAP UNDER THE FRONT FAIRING (CLOSE TO THE BATTERY) AND PLACE THE FUSE HOLDER (SEE FIG. 35).

NOTE:
CLEAN AND DEGREASE THE FAIRING FIXING SURFACE WHERE THE STRAP IS TO BE PLACED TO GUARANTEE THE BEST POSSIBLE STRAP ATTACHMENT.

Fig.35



3.8.17 PLACE THE WIRING HARNESS BATTERY TERMINALS UNDER THE BATTERY STRAP (SEE FIG. 36).

SUGGESTION:
NEVER CONNECT THE BATTERY UNTIL YOU ARE READY TO START THE ENGINE. SEAL THE BATTERY TERMINALS WITH PLASTIC TAPE TO AVOID THAT EVENTUAL VIBRATIONS MIGHT DISCONNECT THE TERMINALS.



Fig.36

3.8.18 SCREW THE SPARK CAP ON THE H.T. COIL (SEE FIG. 37).



Fig.37

3.8.19 FIX THE CAP TO THE H.T. CABLE WITH A PLASTIC CLAMP (SEE FIG. 38).

- INSTALL THE SPARK PLUG.
TORQUE AT 20 ÷ 26 Nm (175÷230 in-lb)
- INSTALL THE CAP ON THE SPARK PLUG.



Fig.38



3.9 INSTALL THE INTAKE SILENCER

-MAKE SURE THAT THE FILTER HAS THE INLET HOLES TOWARDS THE UPPER SIDE.

-FIX THE FILTER ON THE CARB. WITH A STEEL CLAMP AND THE FILTER TO THE CHASSIS SIDE RAILS WITH PLASTIC CLAMPS (SEE FIG. 39).



Fig.39

<p>3.10</p>	<p>INSTALL THE EXHAUST</p> <p>NOTE: SEE SECTION 10 FOR THE RECOMMENDATIONS ON THE IDEAL EXHAUST LENGHT.</p>	
	<p>3.10.1 INSTALL THE FLEXIBLE (L= 65mm FLEXIBLE COMPLETELY CLOSED) AND THE EXHAUST HEADER (SEE FIG. 40) AND FIT THE INSULATING SLEEVE ON THE FLEXIBLE (SEE FIG. 41).</p>	<p>Fig.40</p>  <p>Fig.41</p> 
	<p>3.10.2 INSERT THE FLEXIBLE ON THE EXHAUST HEADER AND FIX WITH THE 3 SPRINGS (SEE FIG. 42).</p>	<p>Fig.42</p> 

THE ENGINE IS READY TO BE STARTED

4- GASOLINE and OIL

Use leaded or unleaded Premium Gasoline ($92 \frac{\text{RON}+\text{MON}}{2}$) mixed with oil at 6% - (16:1).

Use oils containing Castor Oil which guarantees an optimized lubrication at high temperatures.

As on the other hand, use of Castor Oils creates gummy residues which give origin to carbon deposits, it is necessary to check and clean, at least every 5 ÷ 10 hours, the piston and the head.

Our experience dictates use of oils such as:

- SHELL ADVANCE RACING M
- ELF HTX 909
- ERG K KART 2T CORSE
- ERG K KART FORMULA

Once the fuel tank is filled, make sure that gasoline reaches the carburetor before starting the engine.

Never use the electric starter to suck the gasoline as this would discharge the battery.

SUGGESTION:

Disconnect the plastic tube on the carb. and the vent tube on the tank and pressurize the vent tube, until gasoline comes out from the tube on the carb. Make sure there is no air in the tube.

Connect the tube on the carb. and on the vent.

5- CARBURETOR ADJUSTMENT GUIDE

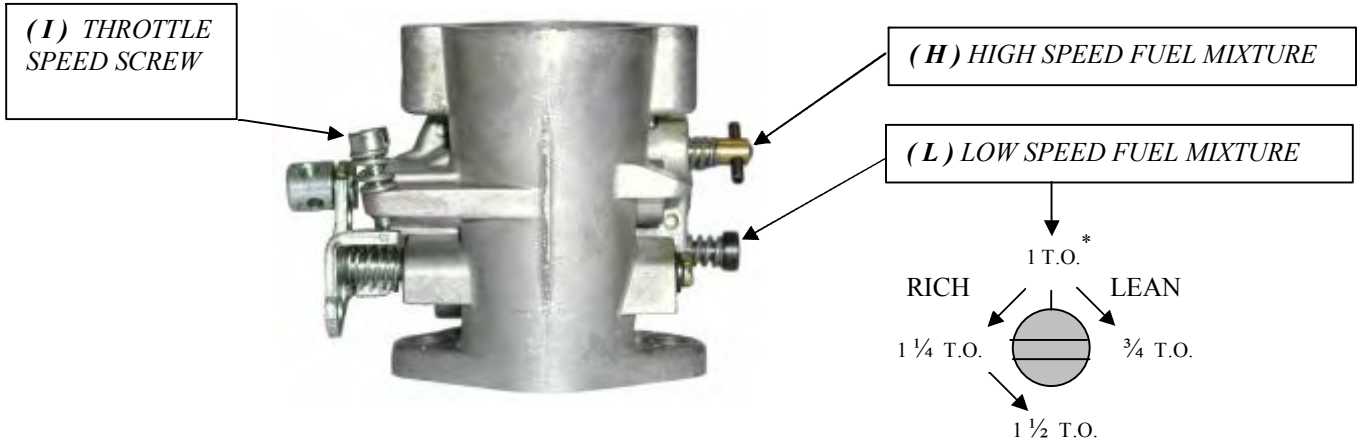

* T.O. = TURNS OPEN

Normally the correct setting of the mixture screws is the following:

- L (close the screw completely and then open): $1 \frac{1}{4} + 1 \frac{1}{2}$ T.O.
- H (close the screw completely and then open): $1 + 1 \frac{1}{4}$ T.O.

Based on various factors as altitude, ambient temperature etc. it might be necessary to reset the carburetor to optimize the performance of the engine.



ATTENTION:

- Never lean too much as lean mixture will overheat engine and cause seizure
- Do not force H or L closed. It may damage the precision machined orifice and render the carb unserviceable.
- The adjustment of screw must be performed with warm engine.

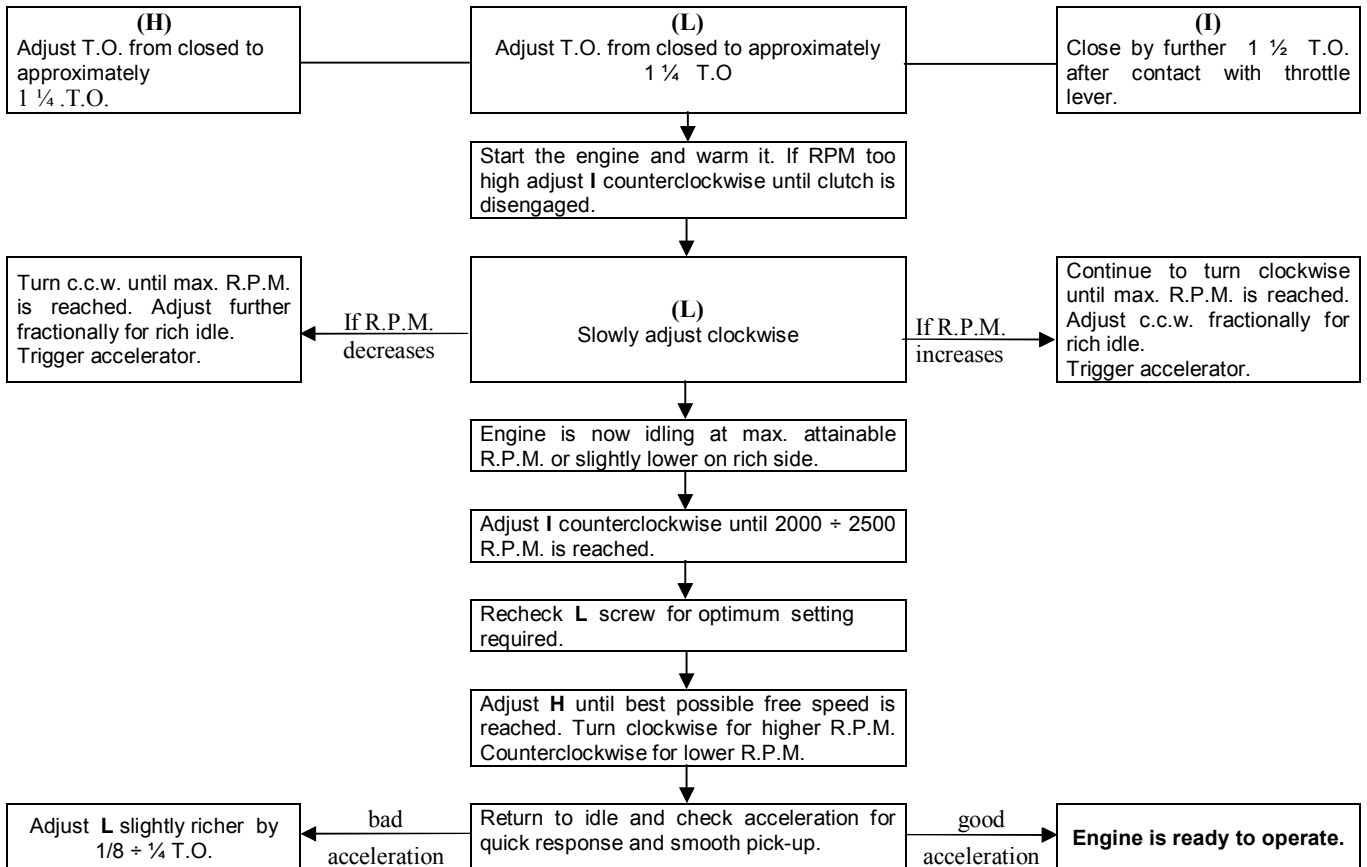

6- STARTING AND STOPPING THE ENGINE

Starting is achieved by the starting key.

This is a 3 position key:

- 1- STOP (key can be removed)
- 2- KEY
- 3- RUN

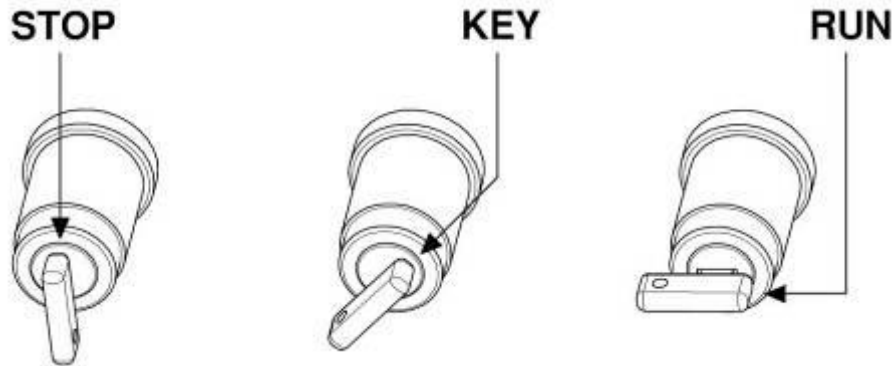

In STOP position the battery is disconnected and the engine stop signal is sent to the electronic box.

In KEY position the battery is connected to the system and the stop signal is removed.

In RUN position the battery is always connected and the electric starter, operation signal is sent to the electronic box.



ATTENTION:

The starting key assembly is supplied with two original keys. We recommend to separate the keys and to keep one in a protected place. In case of loss of both keys, it is necessary to replace the complete assembly.

The starting procedure, from STOP position, is as follows:

- A) Turn the key to KEY position (this connect the battery).
- B) Turn the key to RUN position to start the engine (the electric starter is immediately disengaged when turning the key to KEY position, or when the electronic box detects an engine RPM higher than 1500 RPM).
- C) When the engine is running, the key can be left both in the RUN or KEY position. We suggest, for practical reasons, to turn the key to KEY position; this allows with a single tripping to stop the engine (STOP position) or to restart it in case the engine is stopped (RUN position).

Note:

- ***in case the engine is stopped with the key in RUN position, to restart it, turn the key to KEY position and then again to RUN position to activate the electric starter.***
- ***With the key in KEY or RUN position and if the engine is stopped, to start the engine an external starter unit can also be used.***

In case the engine cannot be started within 5 seconds (check that gas gets to the carb.) interrupt and try again after 15 seconds. Short and frequent tries are better than long ones.

To stop the engine turn the key to STOP position both from KEY (1 tripping) or from RUN (2 trippings).

7- ENGINE BREAK-IN

The break-in of the engine must be performed following a few fundamental rules:

1. Adjust the carburetion. Start with an adjustment on the rich side.
2. Warm the engine gradually for about 5 minutes at half throttle, making some laps at low speed, gently closing and opening the carb. throttle (if a tachometer is installed never exceed 11.000 ÷ 12.000 RPM). **Never keep the same RPM for a long time.**
3. Progressively increase the speed of the kart for 5 minutes at $\frac{3}{4}$ throttle opening. **Never keep the same RPM for a long time.**
4. Increase the speed for 5 minutes, at max. speed on the twisty parts of the circuit and making the engine rich at half straight (cover with the hand for an instant the holes on the air filter, keeping the throttle wide open).



ATTENTION:

Once the break-in is over and the engine is cold, check the torque of the exhaust header nuts as, during the break-in, the nuts tend to become loose (refer to the attached table).

8- RPM LIMITATION

The electronic box incorporates an RPM limiter which prevents the engine from exceeding 17000 RPM.

This limit cannot be exceeded otherwise the engine could be damaged by the extremely high RPM.



ATTENTION:

Do not keep the engine for a long time at the RPM at which the limiter is functioning. This would cause malfunctions on the induction and damage the reed valve.

When choosing the sprocket ratio always refer to a maximum limit of 16500 RPM so that the incorporated limiter is not switched on continuously when the engine is running.

9- INLET SILENCER

Make sure that the inlet holes on the filter are towards the upper side and that they are not plugged.

Make sure that the clamp on the carburetor is not loosen and that the filter is well fastened to the chassis.

Once a while, clean the inside from oil deposits. If necessary remove the rubber filter union and clean it with gasoline or solvent.

10- EXHAUST SYSTEM

Before every test, make sure that the flexible is not damaged. Replace if necessary.



ATTENTION:

In case the flexible is damaged, metallic particles could be sucked in the engine and cause a seizure.

Always make sure that the springs are well hooked and in place. In case of breakage, replace the broken spring. **Never race the kart without the 3 springs in place**, as otherwise the exhaust pipe could vibrate beyond control.

Every 10 ÷15 hours, open the pipe end and make sure that the holes on the internal counter cone are not plugged.

The best performance is achieved with a total exhaust length of:

- $L = 410 \div 415$ mm.

Where L is measured from the flange on the exhaust header up to the first welding on the first cone of the exhaust muffler (see drawing).

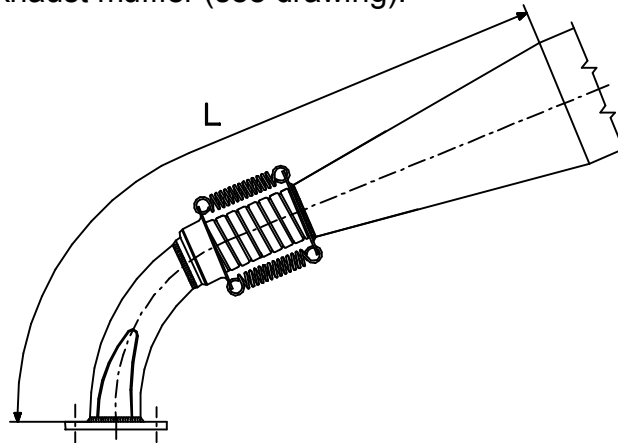

To achieve this dimension, the flexible (supplied with the engine) must be cut at a length of 65mm (flexible completely closed).

Having fixed a sprocket ratio, it could be necessary to improve the engine performance either at low or at high RPM.

This could be achieved by modifying the exhaust length.

In general, by shortening the total exhaust length an improvement at high RPM is achieved and vice versa, by lengthening the exhaust length the low RPM is improved.

When testing, never exceed in lengthening or shortening the flexible by more than 5mm per time.

11- CENTRIFUGAL CLUTCH

The engine has a low maintenance dry centrifugal clutch. The following prescriptions, if carefully followed, will allow a long clutch life.

When starting the engine make sure that the brake pedal is fully pressed to avoid sudden accelerations.



ATTENTION:

Once the engine is started, avoid useless accelerations which can overheat and deteriorate the clutch. Oil the chain before each tests, immediately after each race or test, check the engine sprocket. Replace if necessary.

A bad alignment of the engine sprocket with the axle sprocket or the lack of oil will damage the chain and sprocket.

Check the clutch:

- Every 5 hours of use.
- When metallic noises are heard inside the clutch.
- If the kart dragging speed exceeds 6000 RPM.
- Every time the clutch has overheated (presence of smoke or smell of burning).

To check the clutch, you must remove the clutch cover and the clutch drum.

Replace the clutch:

- whenever the thickness of the friction material (see drawing) is lower than 1.5mm on point A of the clutch or if the body diameter is lower than 82.5mm.
- Whenever the external friction material in the A portion of the clutch is very rough (wear or degradation of the friction material due to overheating).



ATTENTION:

In case the friction material has been totally worn out and there has been a metal contact between the clutch body and the clutch drum, it is necessary to replace the clutch drum. See drawing.

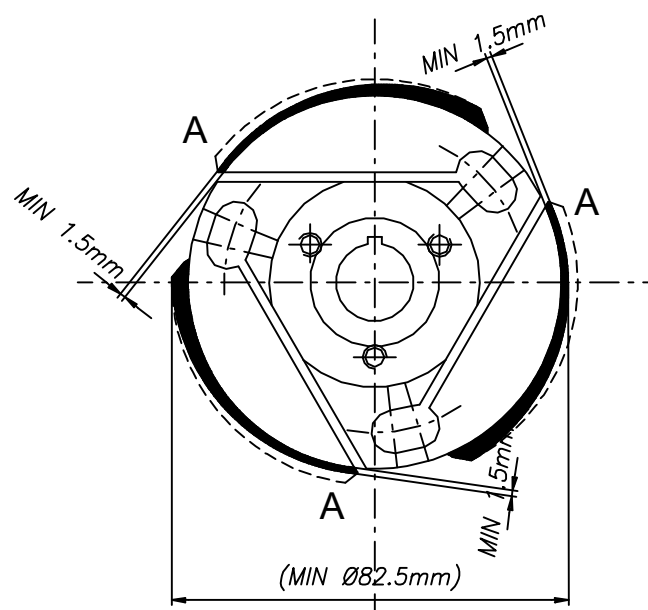

12- INSTRUCTIONS FOR THE DISASSEMBLY / ASSEMBLY OF THE CLUTCH





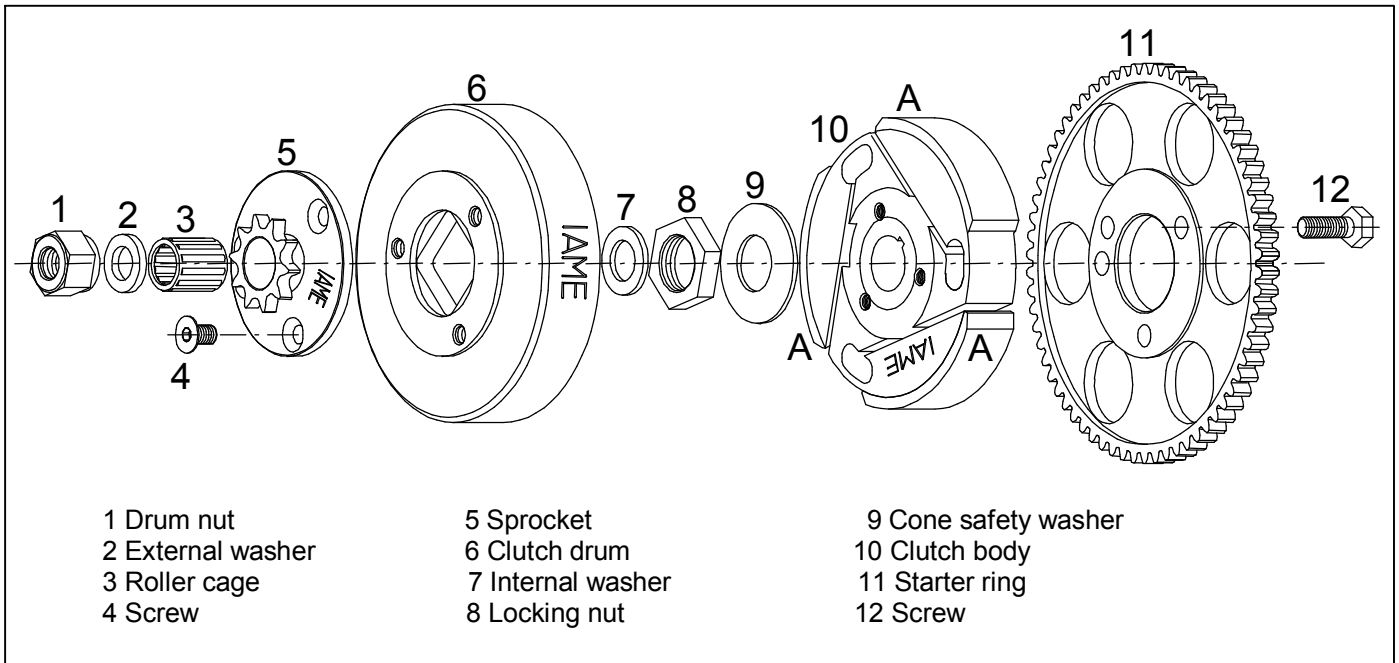

ATTENTION:

The following operations can be performed by a skilled mechanic under the conditions to have available the dedicated tools shown on the text, otherwise it is necessary to apply to an Authorized Service Center.
Refer to the following drawing during the operations.



<u>OPERATIONS</u>	<u>TOOLS</u>
<u>Clutch disassembly</u>	
1. Remove the clutch cover (3 screws M6).	▪ Allen wrench 5mm- T type
2. Remove the spark plug and replace with special tool to prevent crankshaft from turning.	▪ Piston fitting: P.N. 10271
3. Remove nut (1 nut M10).	▪ 12 point wrench 17 mm
4. Remove the external washer, the drum with roller bearing.	
5. Remove the special tool from the head and using the clutch wrench, remove the 16x1 nut and the cone safety washer.	▪ Clutch wrench : P.N. 10270 ▪ 24 mm socket
<u>ATTENTION:</u> <u>Turn clockwise as nut has left thread</u>	
6. Apply clutch puller on clutch and remove clutch with 12 point wrench 19mm.	▪ Clutch puller: P.N. B-55614-C ▪ 12 point wrench 19mm.
7. Remove key from shaft	
8. Remove the starter ring (3 viti M6)	▪ 12 point wrench 10 mm

Before assembling the clutch, wash with diluent the shaft taper, the connecting hole on the clutch body, the clutch drum and the starter ring.

<u>Install clutch</u>	
<p>1. Install the starter ring on the clutch body by matching the 3 holes and the dragging pin. (3 screws M6)</p> <p> <u>ATTENTION: make sure to always install the Ø 7 mm dragging pin as, otherwise, the eventual kick backs could break the screws.</u></p>	<ul style="list-style-type: none"> ▪ 12 point wrench 10 mm (Torque at 10 Nm) (90 in-lb) (Apply Loctite on the threads)
2. Insert key on shaft	
3. Install clutch body and the cone safety washer.	
<p>4. Install the 16 x 1 nut using the clutch wrench.</p> <p> <u>ATTENTION: turn counterclockwise as nut has left thread.</u></p>	<ul style="list-style-type: none"> ▪ Clutch wrench P.N. 10270 ▪ 24 mm. socket (Torque at 40 ÷ 50 Nm) (350 ÷ 440 in-lb)
<p>5. Install the internal washer.</p> <p> <u>ATTENTION: install washer with bevel towards internal part of engine.</u> Clean the roller cage and grease it before installing it on the crankshaft.</p>	
<p>6. Install the clutch drum and the external washer.</p> <p> <u>ATTENTION: install washer with bevel towards internal part of engine.</u></p>	
<p>7. Install the piston fitting to prevent the shaft from turning and install the 10 mm nut.</p>	<ul style="list-style-type: none"> ▪ Piston fitting : P.N. 10271 ▪ 17 mm socket (Torque at 30 ÷ 40 Nm) (265 ÷ 350 in-lb)
8. Install the clutch cover (3 screws M 6)	<ul style="list-style-type: none"> ▪ Allen 5 mm. (Torque at 8 ÷ 10 Nm) (70 ÷ 90 in-lb)

13- **BATTERY**

The battery (12 V – 9 Ah) is sealed and without maintenance.

In order to lengthen the battery life it is necessary though to follow a few recommendations:

- When the tension drops below 12.6V it is necessary to recharge the battery.
- Max. allowed recharging current is 1.8A.
- The ideal recharge is achieved with an average charging current of 0.8 ÷ 1 A. (recharging time of appr.10 h.) and at an ambient temperature between 0° and 40°C.



ATTENTION:

An overcharge or an extremely quick charge with excessive current could damage the battery (the battery would tend to swell).

Choose a battery charger with the following characteristics:

- Feed Tension: 90/250 Vac – 50/60 Hz
- Outlet Tension: 15 V full charge – 13.8 stand-by
- Max outlet current: 2A full charge
- During transportation or storage, the battery could loose its charge due to self discharge (0.1% max per day).
Fully recharge battery before use.



ATTENTION:

**Always connect the - (negative) terminal before and the + (positive) terminal after.
Always disconnect the battery in opposite order.**

- Recharge the battery at least once every 6 months.
- Never put the battery in contact with solvents, gasolines, oils, plastifiers or rags containing such elements. The external case of the battery could be damaged.
- Never press or bend or overheat (by welding) the battery terminals.

Other recommendations

- Pay attention not to have free fires upon or around the battery.
- Never short-circuit the terminals.
- Never open the battery or throw it in the fire.
- In case the electrolyte (diluted Sulfuric acid) gets in contact with skin or clothes, immediately wash with water. In case it gets in touch with eyes, wash and apply for medical assistance.
- Carefully check the external case of battery and replace in case of breakages, swellings of the case or of battery cover.
- Before use, clean the battery from dust and check that the terminals are not oxidized or damaged.
- When the battery comes to an end never throw it in the garbage but deliver it to an authorized disposer.

14- WARNINGS ON THE ELECTRICAL SYSTEM

We are here listing the main warnings on the electrical system.
Please keep this in mind during the whole life of the engine.



ATTENTION:

If these prescriptions are not followed the electrical system and the engine could be damaged beyond repair. No obligation of IAME exists in this case.

- 1) Please turn the key to STOP position every time the engine is stopped. If the key is left in KEY position, for a long time, even if the engine is stopped, the battery would be discharged completely.
- 2) Never disconnect the ground cables with eyelets when the engine is in operation.
- 3) Disconnecting the battery when the engine is in operation DOES NOT increase the engine performance. Vice versa, the ignition advance could become very irregular at low RPM thus reducing the performance.
- 4) To fasten the eyelet terminal (groundings) of the wiring harness always use flat or open washers. Never use tab washers.
- 5) When disconnecting the connectors, always press the fixing tongues. Always pull the connectors to disconnect. NEVER PULL THE CABLES.
- 6) The electronic box and the starting relay must always be installed with their connector towards the bottom to avoid back water, dampness or dirt in the connector body.
- 7) Always correctly fix the H.T. coil with both screws, make sure that the laminations pack on H.T. coil is connected to the engine with the grounding cable. The eyelet connector must be directly in contact with the laminations pack on the H.T. coil.
- 8) Never use H.T. coils different than the original coil on the engine. Use of different coil may cause damages to the electronic box.

- 9) The digital assembly needs use of a resistive spark plug cap or spark plug. The resistor value must be equal or higher than 5 Kohm. Avoid use of resistive H.T. cables.
- 10) **The electrical system is protected against battery polarity reversal. When reversing the connectors on the battery, the protection circuit activates the fuse as soon as the key is on KEY or RUN position. The fuse must then be replaced.**
- 11) **Replace the fuse after having disconnected both terminals on the battery. Only use 5A strip fuse. Use of fuses with higher amperage might damage the electronic box whenever the battery polarity is reversed.**
- 12) Only use sealed lead type batteries as specified by IAME. Only use 12V. batteries.
- 13) Always disconnect the battery from the electrical system when recharging the battery with an external battery charger, otherwise the internal voltage regulator could be damaged.
- 14) DO NOT connect batteries in parallel; this might cause explosions and damages to the operator. The recharge of the battery, in normal conditions, is guaranteed by the electrical system. A few minutes of engine in operation are sufficient to recover the energy lost when starting the engine.
- 15) In case the battery must feed other users (Tachometer, Telemetry etc...), first contact IAME to check the recharge capacity of the system.
- 16) Modifications, interventions and additions to the original electric system might cause malfunctions. No obligation of IAME exists in this case.

15- **SPARK PLUG AND THERMAL DEGREE**

The engine is supplied with a standard **NGK BR10EG** spark plug which represents a good compromise between the needs of a good break-in and the racing needs in normal conditions.

Use of different spark plugs is possible and, as a general information, we are attaching a correspondence list among spark plugs of other brands based on **thermal degree** which represents the capacity of the spark plug to dissipate the internal heat. The colour of the various parts of the spark plug more exposed to the combustion flames gives a good indication on the adequacy of the thermal degree and on the carburetion. It is necessary though to understand which of the two parameters has to be changed and only the experience tells how to identify the most proper thermal degree of a spark plug as lean or rich mixtures can generate the same final look which can also be achieved with a hot or cold spark plug.

See table:

<p>An excessively warm spark plug shows the symptoms listed aside</p>  <p><u>ATTENTION:</u> <u>Always use a warmer than standard spark plug with cold or rainy climates.</u></p>	<ul style="list-style-type: none"> ▪ Extremely clear color, porous look and calcification of the electrodes and of the internal insulation. ▪ Irregularities in the ignition, preignition and detonation with tendency to perforate the top of the piston. ▪ <u>Note:</u> <i>Some of these symptoms can be achieved with lean mixtures.</i>
<p>A correct thermal degree shows:</p>	<ul style="list-style-type: none"> ▪ Colour of the insulator end from yellow grey to dark brown for mixtures respectively lean or rich.

<p>An excessively cold spark plug shows the symptoms, listed aside.</p> <p> ATTENTION: <u>Always use a colder than standard sparkplug with hot climates.</u></p>	<ul style="list-style-type: none"> ▪ Insulator end and electrodes covered with black shady soot. ▪ Ignition difficulties. ▪ Note: a wet or oily electrode could also mean an excessively rich mixture.
--	--

**COMPARISON TABLE BASED ON
THE THERMAL DEGREE**

HOT

↑

BOSCH	NGK	CHAMPION
WO8CS	BR9EG	N54R
WO7CS	BR10EG	N52R
WO6CS	BR11EG	

↓

COLD

16- CHOICE OF THE BEST SPROCKET RATIO

The life of an engine depends upon many factors but most of all upon the speed at which the engine is operated. If an engine is normally operated at speeds higher than what recommended by the manufacturer, the wears and stress of the various components (con-rods, roller cages, bearings etc.) will be such as to drastically reduce the life of the engine itself. It is therefore extremely important that the user respects the operating limits imposed by the manufacturer.

The operating limit for the Leopard engine is 17000 RPM and the RPM limiter is calibrated at this value.

 **ATTENTION:**
Never exceed the above limit. No obligation of IAME exists in case the above limit is exceeded.

In case the user wishes to optimize on the track the sprocket ratio in order to achieve the best possible performance, without abusing the engine, follow the under shown recommendations.

The engines are supplied with a 10 or 11 teeth sprocket (pitch: 7.775mm). Table 1 shows the various ratios between the sprocket on the axle and the engine sprocket given the different axle sprockets.

Tab.1

Sprocket ratio	Teeth n° - Engine sprocket		Sprocket ratio	Teeth n° - Engine sprocket	
	Teeth n° axle sprocket	10		11	Teeth n° axle sprocket
72	7,20	6,55	83	8,30	7,55
73	7,30	6,64	84	8,40	7,64
74	7,40	6,73	85	8,50	7,73
75	7,50	6,82	86	8,60	7,82
76	7,60	6,91	87	8,70	7,91
77	7,70	7,00	88	8,80	8,00
78	7,80	7,09	89	8,90	8,09
79	7,90	7,18	90	9,00	8,18
80	8,00	7,27	91	9,10	8,27
81	8,10	7,36	92	9,20	8,36
82	8,20	7,45			

For the operation limit of 16500 RPM the following table (Tab.2) has been prepared.

SUGGESTION:

- **During the track tests we recommend use of a tachometer recording the max obtained engine RPM.**
- **Use sparkplug caps with a resistance of 5K Ω to avoid eventual interferences between the engine ignition and the tachometer and/or telemetry.**

The following example should clarify the procedure for the optimization of the sprocket. Assume to use the engine with Z=10 teeth engine sprocket and that during the preliminary track tests a Z=72 teeth axle sprocket has been used.





- From table 1 with Z=10 as engine sprocket and Z=72 on the axle sprocket, a ratio of 7.20 is found.
- Make a few laps on the track and, let us assume that you read 14.000 max engine RPM.
- From the table 2 to achieve a max RPM of 16500 RPM (operating limit for the Leopard engine) a sprocket ratio from 8.37 and 8.60 should be used (having used, during the tests, a sprocket ratio of 7.2 and having achieved 14.000 RPM max.).
- From table.1, with these values, a sprocket ratio of 10:84 / 10:86 should be used or, having a Z=11 on the engine sprocket, a ratio 11:92 should be used.

SPROCKET RATIO TO ACHIEVE MAX. 16500 RPM

Tab. 2

Engine Max RPM. during tests	Sprocket ratio														
	6,5	6,7	6,9	7,1	7,3	7,5	7,7	7,9	8,1	8,3	8,5	8,7	8,9	9,1	9,3
13000	8,25	8,50	8,76	9,01	9,27	9,52	9,77	10,03	10,28	10,53	10,79	11,04	11,30	11,55	11,80
13200	8,13	8,38	8,63	8,88	9,13	9,38	9,63	9,88	10,13	10,38	10,63	10,88	11,13	11,38	11,63
13400	8,00	8,25	8,50	8,74	8,99	9,24	9,48	9,73	9,97	10,22	10,47	10,71	10,96	11,21	11,45
13600	7,89	8,13	8,37	8,61	8,86	9,10	9,34	9,58	9,83	10,07	10,31	10,56	10,80	11,04	11,28
13800	7,77	8,01	8,25	8,49	8,73	8,97	9,21	9,45	9,68	9,92	10,16	10,40	10,64	10,88	11,12
14000	7,66	7,90	8,13	8,37	8,60	8,84	9,08	9,31	9,55	9,78	10,02	10,25	10,49	10,73	10,96
14200	7,55	7,79	8,02	8,25	8,48	8,71	8,95	9,18	9,41	9,64	9,88	10,11	10,34	10,57	10,81
14400	7,45	7,68	7,91	8,14	8,36	8,59	8,82	9,05	9,28	9,51	9,74	9,97	10,20	10,43	10,66
14600	7,35	7,57	7,80	8,02	8,25	8,48	8,70	8,93	9,15	9,38	9,61	9,83	10,06	10,28	10,51
14800	7,25	7,47	7,69	7,92	8,14	8,36	8,58	8,81	9,03	9,25	9,48	9,70	9,92	10,15	10,37
15000	7,15	7,37	7,59	7,81	8,03	8,25	8,47	8,69	8,91	9,13	9,35	9,57	9,79	10,01	10,23
15200	7,06	7,27	7,49	7,71	7,92	8,14	8,36	8,58	8,79	9,01	9,23	9,44	9,66	9,88	10,10
15400	6,96	7,18	7,39	7,61	7,82	8,04	8,25	8,46	8,68	8,89	9,11	9,32	9,54	9,75	9,96
15600	6,88	7,09	7,30	7,51	7,72	7,93	8,14	8,36	8,57	8,78	8,99	9,20	9,41	9,63	9,84
15800	6,79	7,00	7,21	7,41	7,62	7,83	8,04	8,25	8,46	8,67	8,88	9,09	9,29	9,50	9,71
16000	6,70	6,91	7,12	7,32	7,53	7,73	7,94	8,15	8,35	8,56	8,77	8,97	9,18	9,38	9,59
16200	6,62	6,82	7,03	7,23	7,44	7,64	7,84	8,05	8,25	8,45	8,66	8,86	9,06	9,27	9,47
16400	6,54	6,74	6,94	7,14	7,34	7,55	7,75	7,95	8,15	8,35	8,55	8,75	8,95	9,16	9,36
16600	6,46	6,66	6,86	7,06	7,26	7,45	7,65	7,85	8,05	8,25	8,45	8,65	8,85	9,05	9,24
16800	6,38	6,58	6,78	6,97	7,17	7,37	7,56	7,76	7,96	8,15	8,35	8,54	8,74	8,94	9,13
17000	6,31	6,50	6,70	6,89	7,09	7,28	7,47	7,67	7,86	8,06	8,25	8,44	8,64	8,83	9,03

17- REPLACEMENT OF THE STARTER BRUSHES

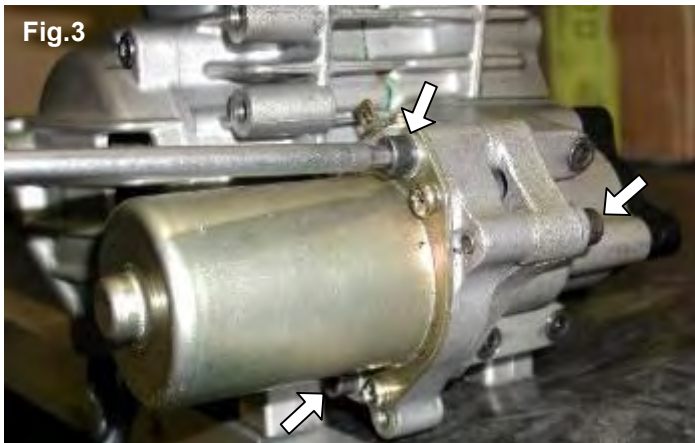
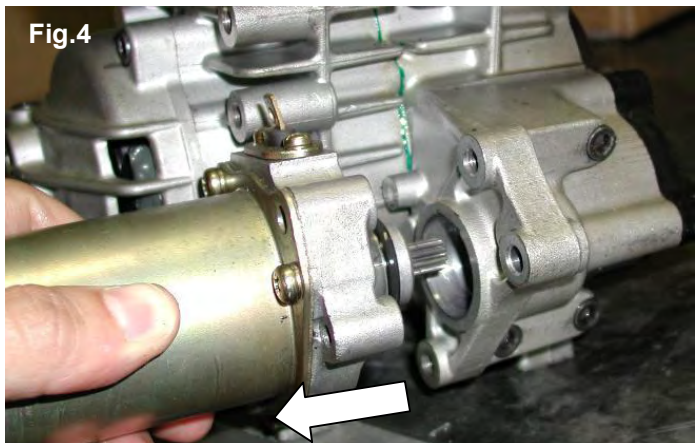
	<u>OPERATIONS</u>	<u>PICTURES</u>
<p>1. <u>DISASSEMBLE THE STARTER</u></p> <p>- UNLOOSE THE SCREW M6X30 ON THE STARTER SUPPORT (see Fig.1).</p> <p> (5mm ALLEN WRENCH – T TYPE)</p> <p>- REMOVE THE STARTER SUPPORT 3 SCREWS M6X25 (see Fig.2).</p> <p> (5mm ALLEN WRENCH – T TYPE)</p> <p>- UNSCREW N°3 SCREWS M6x35 (see Fig.3).</p> <p> (5mm ALLEN WRENCH – T TYPE)</p> <p>- REMOVE STARTER (see Fig.4).</p>		<p>Fig.1</p>  <p>Fig.2</p>  <p>Fig.3</p>  <p>Fig.4</p> 

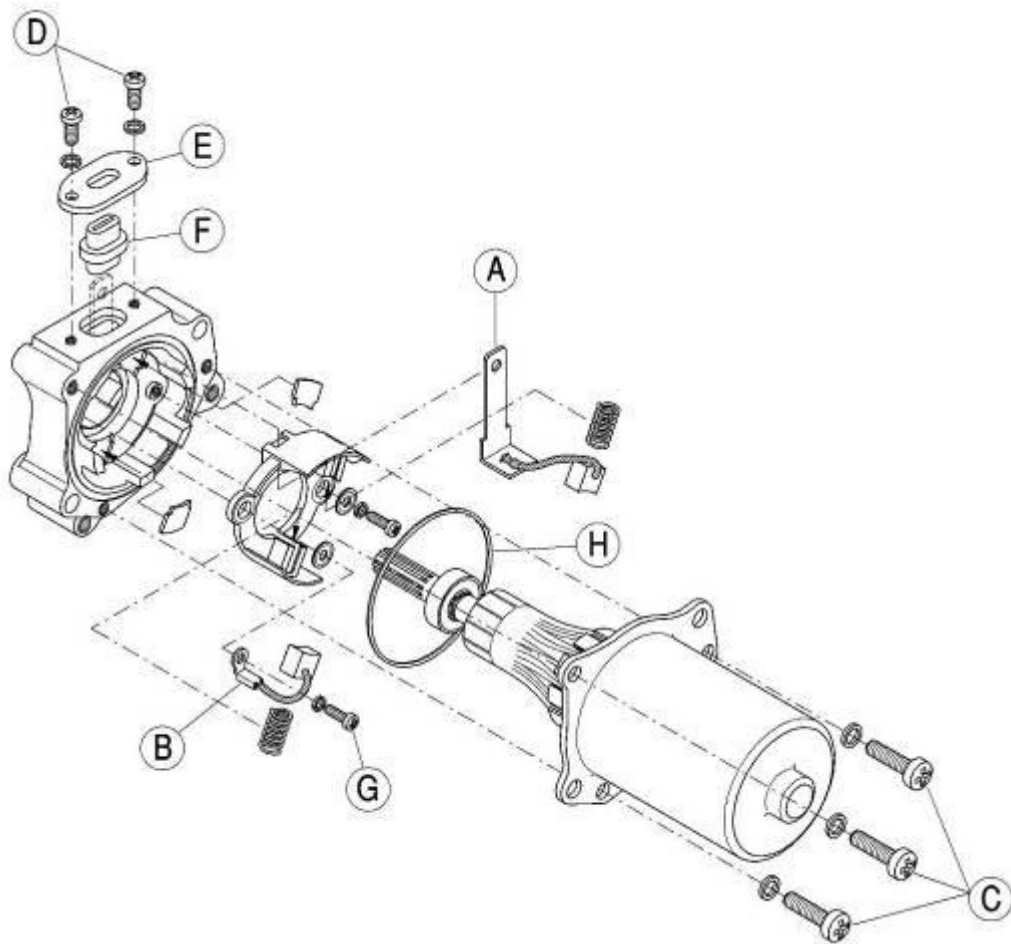

2. OPENING THE STARTER

- REMOVE THE PLASTIC CLAMP AND UNSCREW THE SCREW M4 FIXING THE INPUT CABLE TO THE STARTER (see Fig.5)



(SCREWDRIVER)

- UNSCREW 3 SCREWS M5 "C" (see Fig.6)



(SCREWDRIVER)

Fig.5



Fig.6

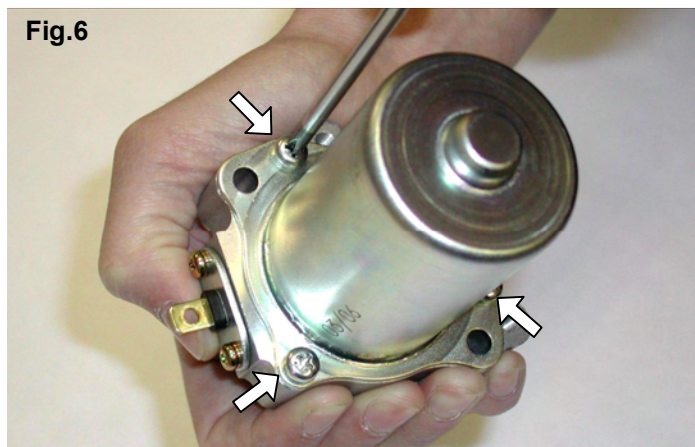

- REMOVE DRUM FROM STARTER
KEEPING ROTOR IN ITS SEAT
(BE SURE TO HOLD THE ROTOR ON ITS
TOOTHED SIDE TO PREVENT BRUSHES
FROM FALLING OUT FROM THEIR SEAT)
(see Fig.7)

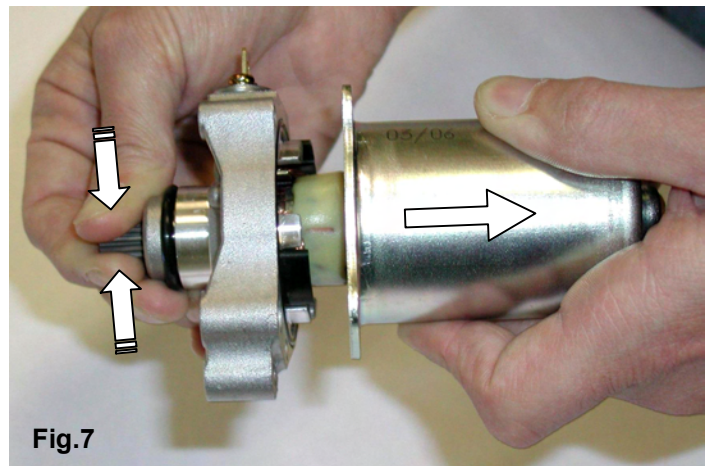

Fig.7

- REMOVE ROTOR FROM STARTER HEAD
(see Fig.8)



Fig.8

⚠ ATTENTION:
WHEN EXTRACTING ROTOR, THE BRUSHES
MAY SPRING OUT FROM THEIR SEATS.

3. REPLACING THE BRUSH "A"

- UNSCREW THE 2 SCREWS M4 "D"
RETAINING THE PLATE "E" (see Fig.9).

(SCREWDRIVER)

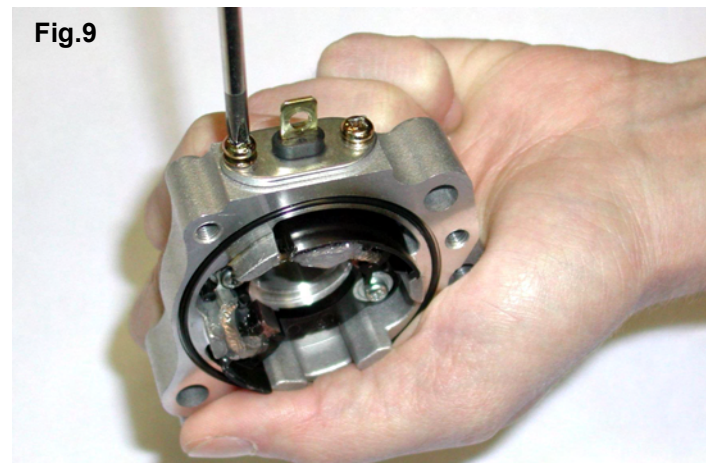

Fig.9

- REMOVE THE LITTLE RUBBER CAP "F" (see
Fig.10).

(PLIERS)



OUR SUGGESTION:
SLIGHTLY OIL THE TIN PLATE TERMINAL
END, TO MAKE EASIER THE EXTRACTION OF
THE LITTLE RUBBER CAP.

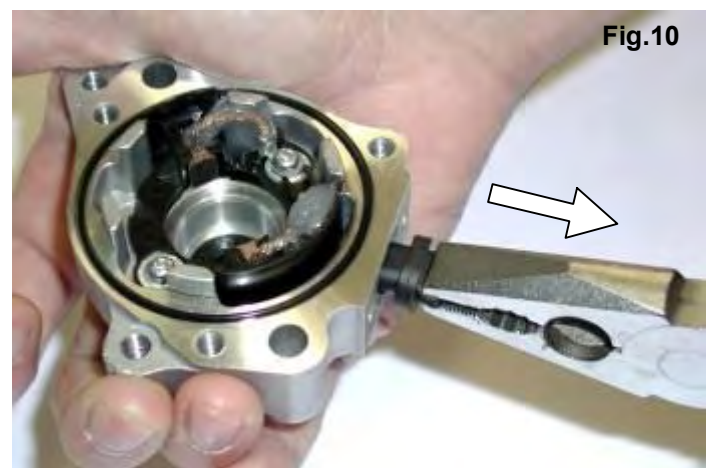

Fig.10

- REMOVE SILICONE FROM BRUSHES WITH A SCREWDRIVER (see Fig.11).

- REMOVE SPRINGS

- MAKING PRESSURE EXTERNALLY ON THE TIN PLATE TERMINAL, REMOVE BRUSH. (see Fig.12).

- INSTALL NEW BRUSH TERMINAL INSIDE (see Fig.13).

- PLACE LITTLE RUBBER CAP ON THE TERMINAL

- REINSTALL THE PLATE AND FIXE IT WITH THE 2 SCREWS M4 (see Fig.14).

(SCREWDRIVER)

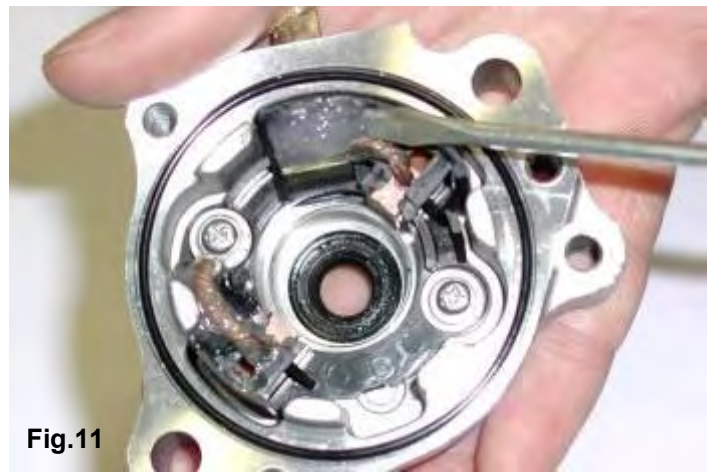

Fig.11

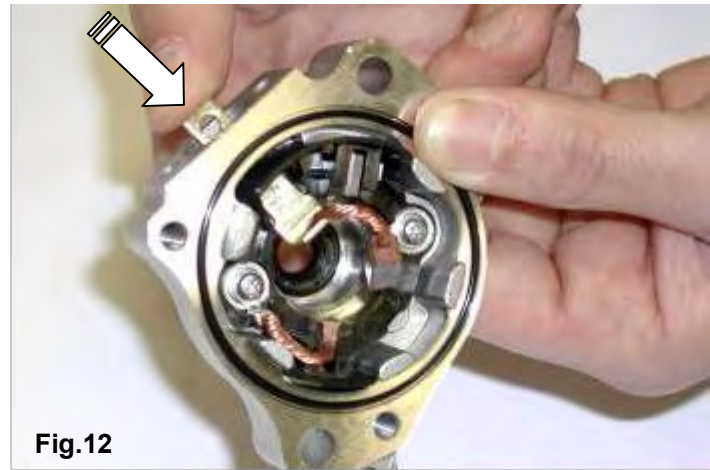

Fig.12

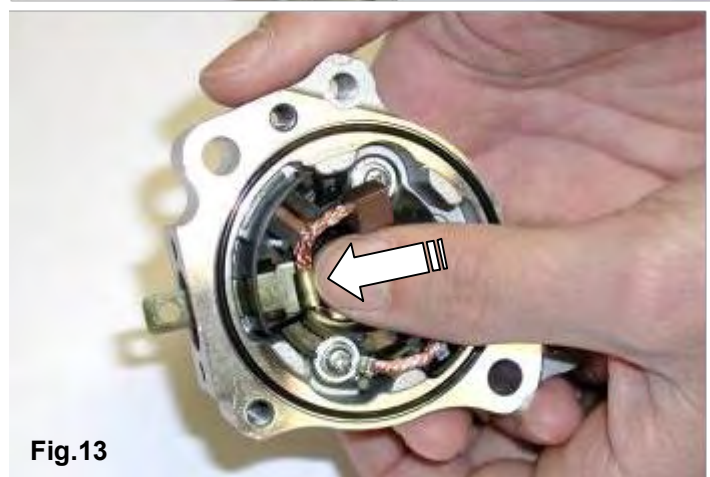

Fig.13

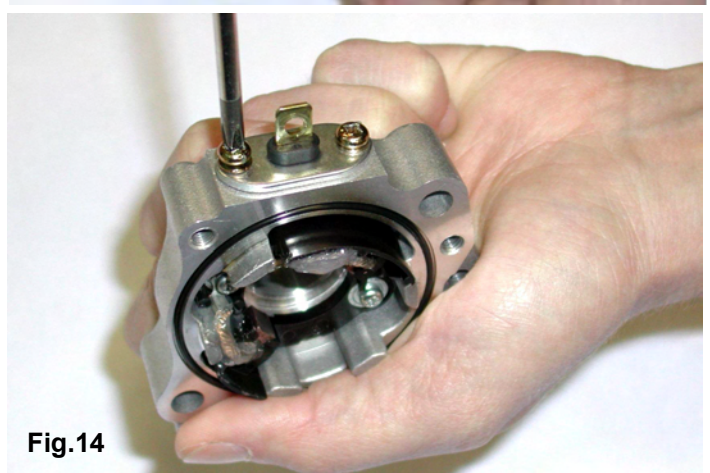

Fig.14

4. REPLACEMENT OF THE BRUSH "B"

- UNLOOSE THE SCREW M3 "G" (see Fig.15)
- EXTRACT THE BRUSH
- FIX THE NEW BRUSH WITH SCREW M3
(SCREWDRIVER)



5. CLOSING THE STARTER

- INSERT THE NEW BRUSH SPRING "A" INTO ITS SEAT.
 - INSTALL THE BRUSH .
 - KEEP THE BRUSH IN PLACE BY PRESSING TOWARDS THE OUTER AND CLAMP IT WITH AN IRON WIRE BENT AS A HOOK.
- REPEAT THE SAME PROCEDURE TO INSTALL THE BRUSH "B" (see Fig.16).

- INSTALL THE STARTER ROTOR BETWEEN THE BRUSHES AND CHECK, THAT THEY ARE ALWAYS IN CONTACT WITH THE CYLINDRIC COPPER PART OF THE ROTOR, EVEN WHEN THEY ARE RELEASED (see Fig.17).

**OUR SUGGESTION:
TO IMPROVE THE BRUSHES LIFE, SECURE THE LITTLE WIRES WITH SILICONE (see Fig.18).**

Fig.15



Fig.16

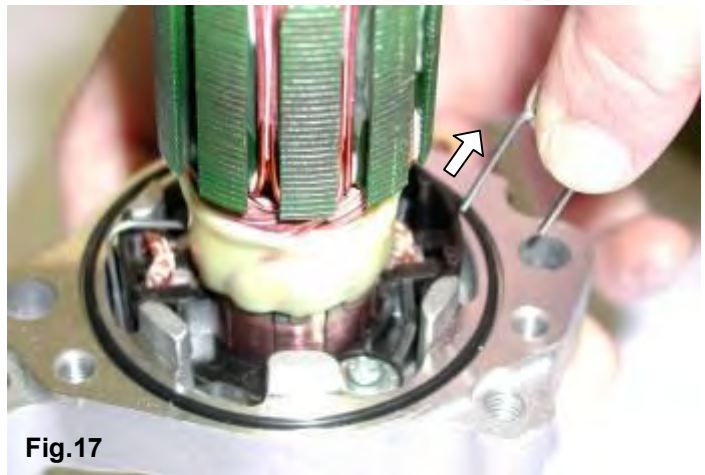

Fig.17

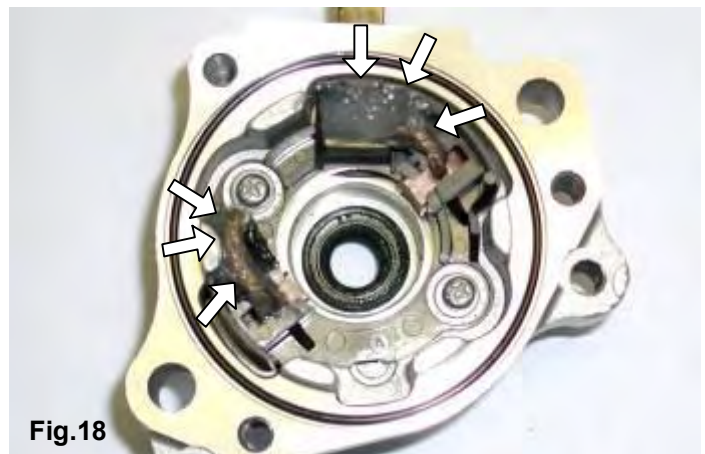

Fig.18

- CHECK THAT O-RING "H" IS INSTALLED ON THE STARTER HEAD.

- INSERT STARTER DRUM ON THE HEAD BEING CAREFUL TO PREVENT ROTOR FROM ROTATING AND TO PREVENT THE BRUSHES FROM FALLING OUT OF THEIR SEAT (see Fig. 19).

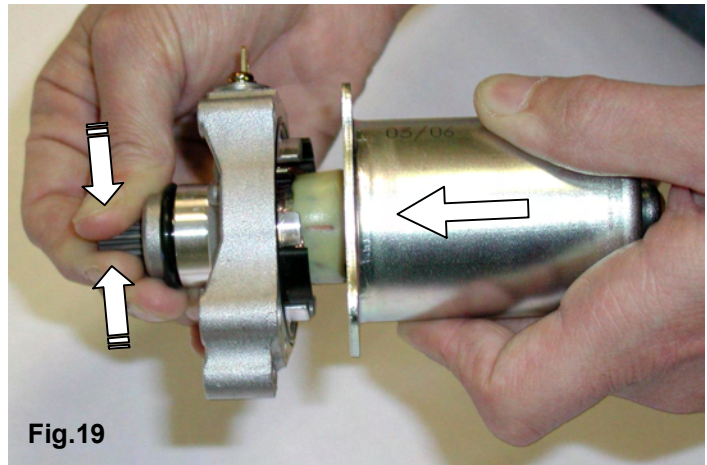

Fig.19

- SCREW THE 3 SCREWS M5 (see Fig.20).
(SCREWDRIVER)



Fig.20

- CHECK THAT THE STARTER ROTOR ROTATES FREELY.

- CONNECT THE INPUT WIRING TO THE STARTER WITH THE SCREW M4 (see Fig.21).



Fig.21

(SCREWDRIVER)

6. ASSEMBLING THE STARTER

- PLACE THE STARTER IN SEAT (see Fig.22).
OIL O-RING TO MAKE EASIER
INSTALLATION.

N°3 SCREWS TCH M6x35
TIGHTEN AT A 8÷10 Nm (70÷90 in-lb)

(5mm WRENCH – T TYPE)

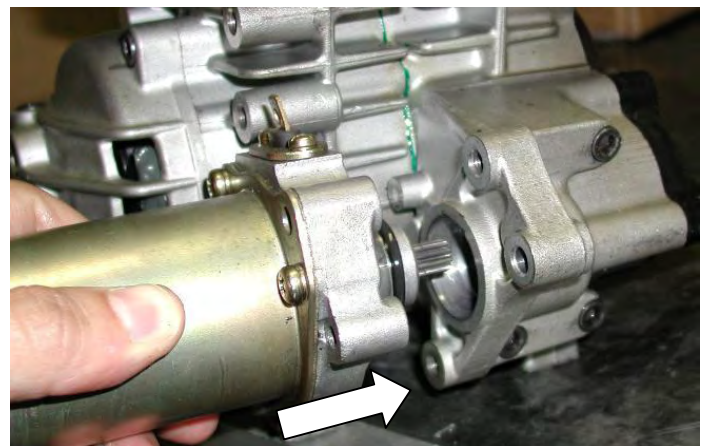

18- SCHEDULED MAINTENANCE

Following some simple maintenance standards will allow the engine to perform more reliably and have a longer life.

SCHEDULE	COMPONENTS	ACTIONS AND COMMENTS
Before using	Exhaust flexible	Check status
	Exhaust spring	Check status
	Exhaust strap	Check status
	Silencer	Check status and fixing
	Engine sprocket	Check wear Check alignment with axle sprocket
	Engine chain	Check status tensioning and oil chain
	Battery	Check status and charge
	Cables and connectors	Check status and connections
	Grounding of engine and electronic box	Check status and connections
	Engine mount and clamps	Check torques
After use	Battery	Disconnect
	Chain	Check status and oil chain
	Engine	External cleaning
Every 5 ÷ 10 hours	Bendix assembly	Remove cover (see fig.) and clean internally
		
	Exhaust muffler	Remove muffler end, clean
	Inlet silencer	Open, clean
	Engine head	Open, clean
	Engine clutch	Open, check status of parts
	Every 20 hours	Piston and con-rod assembly
Crankshaft		Check and replace worn parts
Ball bearings		Check and replace worn parts

19- TROUBLESHOOTING

Below are some common faults, their probable causes and suggested remedy:

<u>FAULTS</u>	<u>PROBABLE CAUSES</u>	<u>REMEDY</u>
Starter will not crank when turning the key to RUN position	Bad connections on starter cables.	Check and tighten
	Bad grounding	Check connections and tighten.
	Interruption on fuse	Replace 5A strip fuse, after checking for eventual reversal of battery polarity.
	Damaged cables	Replace
	Battery connections loose	Check and tighten
	Battery discharged	Recharge battery
	Starter failure	Overhaul starter
	Relay failure	Replace relay
Starter cranks but engine won't start when turning the key in RUN position	Electronic box	Apply to Authorized Service Centers
	Bad cable connections	Check connectors
	Bad H.T. coil connection or coil failure	Check/Replace
	Bad H.T. coil grounding	Check grounding
	Electronic box or ignition failure	Apply to Authorized Service Centers
	Wet spark plug	Replace
Engine starts but it stops after a few seconds when turning the key in RUN position	Malfunction on induction system	Check status and connection on fuel pipe Replace gaskets and membranes on carburetor Check reed petals. Replace if necessary
	Bad cable connections	Check stator connector
	Electronic box or starter failure	Apply to Authorized Service Centers
Engine starts but it stops after a few seconds when turning the key in RUN position	Bad carburetor adjustment (I screw)	Check carburetor adjustment (see sect. 5)
	Bad carburetor adjustment (L screw)	Check carburetor adjustment (see sect. 5)
The starter cranks also after the engine is running.	Electronic box failure	Apply to Authorized Service Centers
Rough idle	Bad carburetor adjustment (L screw)	Check carburetor adjustment (see sect. 5)
Drop in engine performance	Bad compression	Check piston
	Bad carburetor adjustment	Check carburetor adjustment (see sect. 5)
	Insufficient gas flow	Check fuel flow lines and inlet filter
	Dirty inlet silencer	Check and clean
Burning smell, smoke	Overheating of clutch	Check clutch (see sect. 11)
Clutch engages at too high RPM	Excessive wear of friction material	Check clutch (see sect. 11)
Exhaust too noisy	Flexible damaged	Check and replace if necessary
	Springs damaged or lost	
	Insulating strap damaged or lost	
	Damaged exhaust header	

20- ENGINE PRESERVATION

When engine is to remain unoperative for a long period it must be preserved as follows:

- Disconnect the battery and charge it periodically (see Sect. 12).
- Disconnect carburetor and clean it.
- Seal with tape the engine inlet and exhaust.

The external of the engine must be cleaned. Spray with protective oil the steel parts subject to oxidation.

Keep the engine in a dry ambient.

21- TORQUE VALUES

NOMINAL SIZE	Q.TY	FASTENER NAME	WRENCH	VALUES(Nm)	VALUES(in•lb)
M14 x 1.25	1	Spark plug	Hex.20.8	20 – 26	175 – 230
M8 x 1.25	4	Head and cylinder nut	Hex. 13	18 – 22	160 – 190
M6 x 1	3	Exhaust nut	Hex. 10	9 – 11	80 – 100
M6 x 1	4	Reed group screw	Allen 5	8 – 10	70 – 90
M6 x 1	2	Carburetor attach. nut	Hex. 10	6 – 10	50 – 90
M5 x 0.8	2	Air filter screw	Allen 4	5 – 6	45 – 50
M5 x 0.8	2	Coil attach. screw	Allen 4	5 – 6	45 – 50
M5 x 0.8	4	Ignition stator fixing screw	Allen 4	5 – 6	45 – 50
M10 x 1	1	Ignition rotor fixing nut	Hex. 17	20 – 26	175 – 230
M6 x 1	4	Starter support fixing screw	Allen 5	8 – 10	70 – 90
M6 x 1	3	Counter shaft support screw	Allen 5	6 – 8	50 – 70
M6 x 1	3	Starter attach. screw	Allen 5	8 – 10	70 – 90
M6 x 1	3	Clutch cover attach. screw	Allen 5	8 – 10	70 – 90
M10 x 1	1	Clutch drum holding nut	Hex. 17	30 – 40	265 – 350
M16 x 1	1	Clutch fixing nut	Hex. 24	40 – 50	350 – 440
M5 x 0.8	3	Engine sprocket fixing screw	Allen 3	6 – 8	50 – 70
M6 x 1	3	Starter ring fixing screw	Hex. 10	9 – 11	80 – 100
M6 x 1	7	Crankcase fixing screw	Allen 5	8 – 10	70 – 90
M6 x 1	3	Add. starter supp. fix. screw	Allen 5	8 – 10	70 – 90
M6 x 1	1	Additional supp. locking screw	Allen 5	8 – 10	70 – 90

