

LA CROSSE[®] TECHNOLOGY



Wi-Fi COLOR WIND SPEED + WEATHER SYSTEM

SET UP GUIDE

MODEL NUMBER V23

Register Your Product and Double Your Warranty



[Scan Here](#)

Scan the QR Code or visit: bit.ly/v23_register
to register your product and to double the standard one-year
warranty for free by opting to receive occasional product emails.

Table of Contents

BASICS

Initial Setup	02
Display Settings	06
Buttons	07
LCD Display Brightness	08
Auto-Dim Settings	08
Time & Calendar Display	09

PRESSURE

Relative Pressure	13
-------------------	-----------

WIND

Viewing Wind Data	14
Wind Speed Records	15
Customizable Alerts	18

APPENDIX

Specifications	25
Cautions & Statements	25-28
Recycling & Disposal	28

LA CROSSE VIEW

Connecting to the App	03
Connecting Your Display	04
Adding Your Sensors to the App	05
Data Stream Technology	09

TEMP. AND HUMIDITY

Viewing Temperature and Humidity Data	16
Temperature and Humidity Records	17
"Feels Like" Temperature	17
Customizable Alerts	18

SUPPORT

We're Here to Help	28
Factory Reset	28
Stay in Touch	28

FORECAST

Viewing Forecast Data	10-12
Viewing Extended Daily and Hourly Forecast Data	11
Day/Night Forecast	12
Moon Phase	12

SENSORS

Placement & Mounting	19
Glide Pro Sensor Installation	20-21
Add-On Sensors	22-23
Adding Sensors to Your Display	24
Viewing Your Add-On Sensor Data	24

Initial Setup

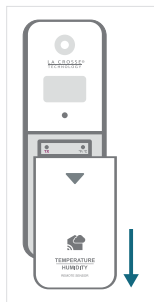

Thermo-Hygro Sensor
(LTV-TH2i)

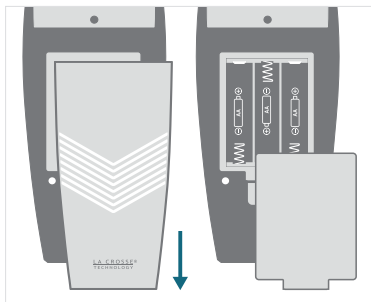

Glide Pro Sensor (LTV-W3)

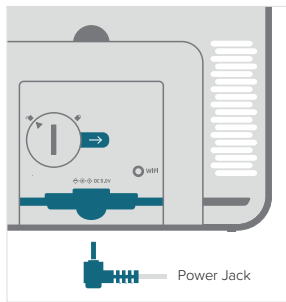

Back of Display (V23)

Power Up

Thermo-Hygro Sensor

Slide the battery cover down to remove it. Install 2 fresh "AA" batteries according to polarity and snap the cover back into place. The blue LED light will flash when transmitting.

Glide Pro Sensor

Slide the outer cover down to remove it. Then remove the inner battery cover and install 3 fresh "AA" batteries according to polarity. Replace both the battery cover and outer cover.

Display

Insert the 5V Power Adapter into an outlet, and then plug it into the Power Jack on the bottom of the display. Next, remove the Insulation Tab from the Battery Compartment. About 30 seconds after powering on, it will automatically enter the Settings Menu. See page **06** for more details.

Connecting to the App

La Crosse View®

Stay connected to your home anytime, anywhere with the La Crosse View app.

Monitor your home environment and set custom alerts to notify you when conditions change.

Connecting is optional and the display will function as a standalone unit without the Wi-Fi connection. However, we recommend connecting during the initial setup, as it will save you time and allows access to some advanced features right away.

Download the La Crosse View App

Visit the App Store or Google Play Store to download the free La Crosse View app onto your mobile device.

Launch the App

Open the La Crosse View app. Follow the on-screen setup instructions to create an account, add new devices, and connect your display to your Wi-Fi network.

Connecting Your Display to the App

Now that you've created your La Crosse View account, it's time to add your system to your account and connect it to your home router using the La Crosse View app.

Note: For the steps listed on the next page, you'll need your Wi-Fi network name (SSID) and password. Make sure your mobile device is connected to the same Wi-Fi network.



Adding & Connecting Your Display to Wi-Fi

1. The La Crosse View app is required to connect the display to your Wi-Fi network. Download, install, and log into your La Crosse View account first.
2. Follow the initial app instructions or manually add the display into your account.

New User Initial Setup: When first setting up your system, the app will lead you through a series of instructions to help get your system added into your account and connected to your home Wi-Fi network.

Manually Add & Connect Display: After the initial walkthrough, displays can be added and connected via the Devices tab in the app's main menu. Simply tap the **Add Device** or **+** button at the bottom of the Devices page in the app.
3. Next, the app will prompt you to use your phone to scan the device ID barcode located on the back of the display. Please note, adding a device to your account and connecting it to Wi-Fi are two different steps. You can complete either step separately if you have any trouble.
4. When connected, the display will beep, and time and forecast information should appear on the screen. The  indicator will also become solid.

Checking Your Display's Wi-Fi Status

Press the **SET** button on the top of the display to view your Wi-Fi Status.

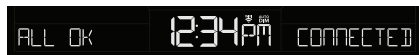

ALL OK CONNECTED: Your system is connected to your Wi-Fi and its data should be available on the display and in the app.



NO WEATHER SERVICE: Your Internet weather and time services are not connecting. These should resolve on their own, please be patient.



SEE APP TO CONNECT: Check the app for notifications.

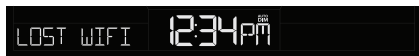

LOST WIFI: Check your router and network connections.



Having Trouble Connecting to Wi-Fi?

The app should guide you through the best method for your Wi-Fi network and router. However, if you have trouble connecting, please go to: bit.ly/wifi_questions or scan the QR code. This will explain additional connectivity options, including connecting by WPS or contacting our technical support team for further assistance.

Adding Your Sensors to the App

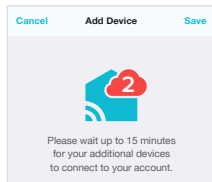

Upon getting the display connected to your Wi-Fi network, the app will explain how your connected sensors should be brought in. Within the next 15 minutes, you should receive an Add Device notification in your app. This is indicated by the Red Cloud and the number inside of it. Tap this icon to begin adding your sensors into the app.

Manually Add Your Sensors to the App*

1. Open your La Crosse View app. On the Main Menu, scroll to **ADD/EDIT** and select **DEVICES**.
2. On the Devices page, select the **ADD DEVICE** or **PLUS (+)** button.
3. Scan the Barcode on your Sensor or type in the Device ID manually.
4. Confirm the sensor image and Device ID and add a Device Name and Location Name. Select **DONE**.



▲ Back of Thermo-Hygro Sensor
 Inside of Glide Pro Sensor ▶

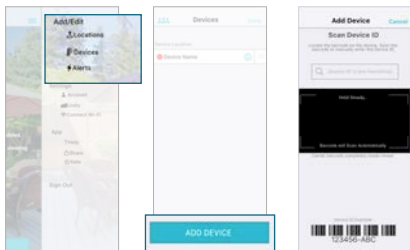
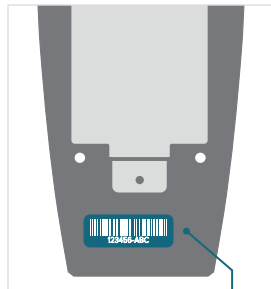

* This step is only required if you do not receive the Add Device notification within the app.

Prior to mounting/positioning your sensors, make sure your display is receiving sensor data.

Display Settings

About 30 seconds after powering on, the display will automatically enter the Settings Menu. Use the steps below to navigate the menu and get your display working the way you'd like.

Navigating the Settings Menu



1. To manually set language, time/date, and other settings, hold the **SET** button to enter the Settings Menu.

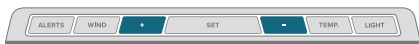

2. Use the +/- buttons on the top of the display to adjust the values.



3. Press the **SET** button to confirm your selection and move to the next setting.



4. You may exit the Settings Menu at any time by pressing the **LIGHT** button.

Settings Menu Order

- HELLO Greeting
- Language (English/Spanish/French/German)
- Beep On/Off
- Time Format (12 or 24 Hour)
- Hour | Minute | Year | Month | Date
- Calendar Order (Month/Date or Date/Month)
- Temperature Units (Fahrenheit or Celsius)
- Temperature Decimal On/Off
- Pressure Units (InHg or hPa)
- Custom Pressure Value
- Wind Speed Units (MPH or KPH)
- Wind Direction (Letters or Degrees)
- THANK YOU Message

Important: Settings such as language and units of measure must be set manually within the display Settings Menu. These are not controlled by the La Crosse View app.

- The language selected will affect menu instructions as well as weekday and month readouts.
- Weekday will set automatically after year, month, and date settings are adjusted.
- When in 24 hour time format, seconds will show in place of AM/PM markings.
- If you're connected to Wi-Fi, the time/date will automatically update from the Internet. See pages **03-05** for more info.

Buttons

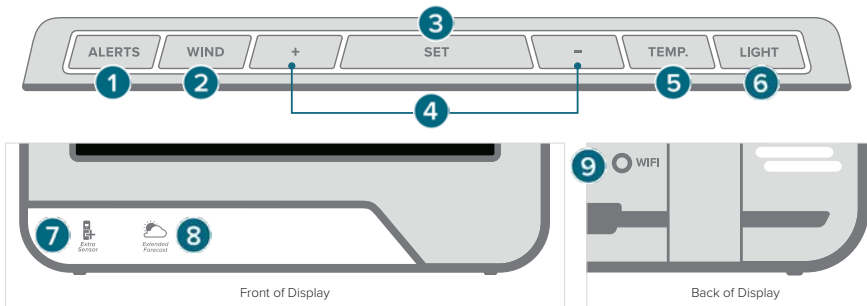

- 1. ALERTS:** Hold to enter Alert Settings. Press to confirm and move to next item. Use the + or - buttons to arm or disarm an alert, and to adjust alert values.
- 2. WIND:** Press to view Wind Speed History. While viewing, hold the **MINUS (-)** button to reset the history value. Hold the **WIND** button to search for the Glide Pro sensor.
- 3. SET:** Press to view Wi-Fi status. Hold to enter the Settings Menu.
- 4. PLUS/MINUS (+/-):** Use to adjust values. When in Alert Settings, press to arm/disarm alert.
- 5. TEMP:** Press to view Temperature & Humidity History. While viewing, hold the **MINUS (-)** button to reset history value. Hold the **TEMP** button to search for the Thermo-Hygro Sensor.
- 6. LIGHT:** Press to adjust backlight or to exit settings. Hold to enter Auto-Dim settings.
- 7. EXTRA SENSOR (📶):** Tap to view sensor ID numbers. While viewing, hold the **MINUS (-)** button delete the sensor. Hold the **EXTRA SENSOR (📶)** button to search for new sensors.
- 8. EXTENDED FORECAST (🌩️):** Tap to see Daily or Hourly Forecast. Hold to auto-scroll forecast data.*
- 9. WIFI:** Press during initial setup for Wi-Fi Connection. Hold to re-enter Configuration Mode and clear previous Wi-Fi settings.

* Your display must be connected to Wi-Fi to receive Daily/Hourly forecast information.

LCD Display Brightness



Adjusting the LCD Display Brightness

Press the **LIGHT** button on the top of the display to adjust the backlight intensity. There are four brightness levels, plus an off option.

Auto-Dim Settings

Program your display to automatically dim during preselected times.

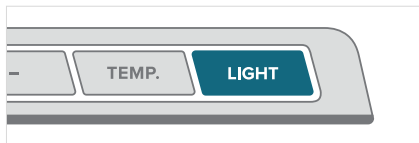

1. Hold the **LIGHT** button to enter the Auto-Dim Settings Menu.



3. Press the +/- buttons to adjust the starting hour. Press **LIGHT** to confirm.

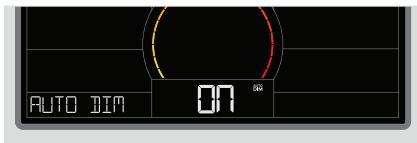

2. Press the +/- buttons to turn the Auto-Dim feature on/off. Press **LIGHT** to confirm.



4. Press the +/- buttons to adjust the stopping hour. Press **LIGHT** to confirm and exit.

Time & Calendar Display



- 1. WEEKDAY:** Full day of the week display.
- 2. 12/24 HOUR TIME:** Time will automatically update when connected to Wi-Fi.
- 3. WI-FI ICON (📶):** Indicates active Wi-Fi connection.
- 4. AUTO-DIM ICON (🌙):** Indicates Auto-Dim is active.
- 5. LOW BATTERY INDICATOR (🔋):** Appears when station battery needs to be replaced.
- 6. CALENDAR:** Select Month/Date or Date/Month order in the Settings Menu.

Data Stream Technology®

Data Streams allow you to see additional AccuWeather information in the time and calendar section on the display. Learn how to set these up in our video here: bit.ly/datastream_vid

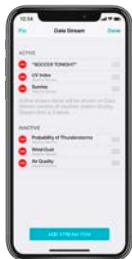

Stream Options Examples:

- UV Index
- Sunrise/Sunset Times
- Chance of Thunderstorms
- Air Quality
- Personal Message

Check the La Crosse View app for a comprehensive list of Data Stream options.

* Your display must be connected to Wi-Fi to receive Data Stream information.

Viewing Your Forecast Data

When using as a standalone unit, the display uses changes in barometric pressure to predict your weather to come. This is represented by the 6 forecast scenes below. High and low temperatures will come from the Thermo-Hygro Sensor. Watch our Forecast Icon Video for more details: bit.ly/forecast_vid

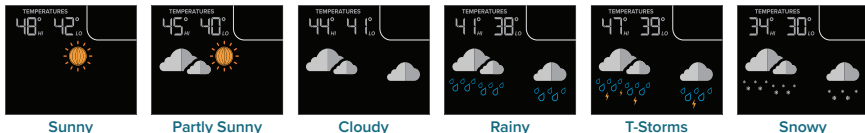

Enhanced Forecast Data Powered by AccuWeather

When connected to Wi-Fi, the display will receive additional weather icons, chance of precipitation values, and future forecast information from AccuWeather. Additional forecast scenes include:

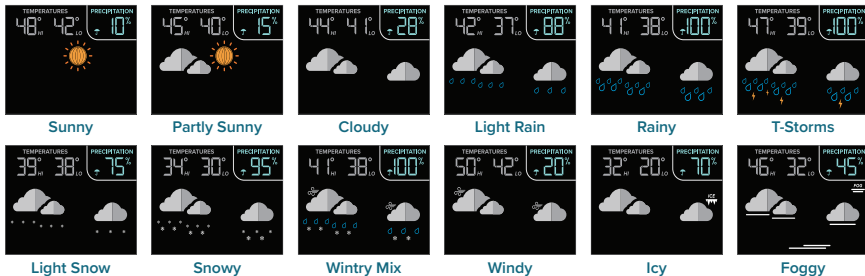

The Internet Indicator icon () and word **FORECAST** will appear at the top of the forecast section when your display is connected and receiving AccuWeather data.

Viewing Extended Forecast Data

Hourly & Daily Extended Forecasts

When connected to Wi-Fi and opted in for weather services in the La Crosse View app, tap the **EXTENDED FORECAST** (🔍) button on the front of the display to toggle through your next 12 hours and next 7 days of forecast data.

Hourly and daily forecast predictions provide different sets of data from AccuWeather. They use Internet sources and do not include measurements from your outdoor sensors.

Note: Your display must be connected to Wi-Fi to receive Extended Forecast data. These are Internet predictions from AccuWeather and do not use data from your outdoor sensors.

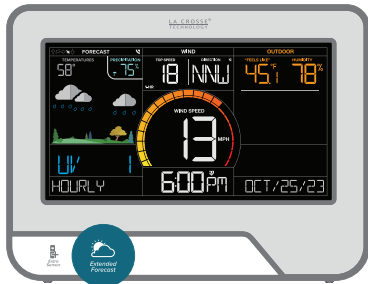

Hourly Forecast Data Includes:

- Forecast Icons
- Chance of Precipitation
- Wind Speed & Gust
- Wind Direction
- Current Temperature
- “Feels Like” Temperature*
- Outdoor Humidity
- UV Index

Daily Forecast Data Includes:

- Forecast Icons
- Chance of Precipitation
- Wind Speed & Gust
- Wind Direction
- MIN/MAX Temperatures
- UV Index

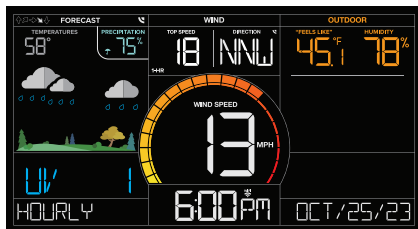

Hourly Forecast Example

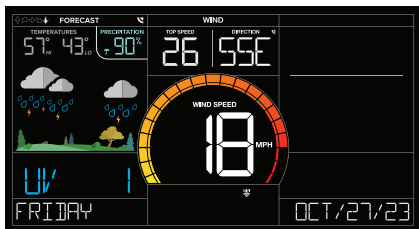

Daily Forecast Example

* “Feels Like” Temperature only appears when conditions are met, see page 17 for more information.

FORECAST

Viewing Your Forecast Data

Daytime Forecasts & Moon Phase

When clear or partly clear conditions are predicted during the daytime (7:00am to 6:59pm), the sun icon will show. From 7:00pm to 6:59am, the Moon Phase will appear regardless of forecast. These times are preprogrammed and cannot be adjusted. The moon icon is based on the lunar calendar and year, month, & date settings. The phases include:



Day Forecast (partly clear example)



Night Forecast (partly clear example)



New Moon



Small Waxing Crescent



Large Waxing Crescent



First Quarter



Small Waxing Gibbous



Large Waxing Gibbous



Full Moon



Large Waning Gibbous



Small Waning Gibbous



Last Quarter



Large Waning Crescent



Small Waning Crescent

Trend Arrows

The arrows represent changes in pressure over the past 3 hours.

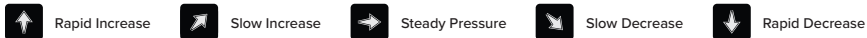

Rapid Increase

Slow Increase

Steady Pressure

Slow Decrease

Rapid Decrease

Seasonal Trees

The foliage scene in the forecast section changes seasonally. The dates are pre-programmed.



Spring (March 20th to June 20th)

Summer (June 21st to Sept. 20th)

Fall (Sept. 21st to Dec. 20th)

Winter (Dec. 21st to March 19th)

Relative Pressure

The Relative Pressure reading will come from your display's internal barometer.

- Please allow up to 10 days for automatic calibration, or program your local pressure value in the Settings Menu.
- The default pressure reading is 29.91 InHg (1013 hPa). The display will acclimate on its own if the pressure value is not set.
- Select your preferred unit of measurement (hPa or InHg) in the Settings Menu.

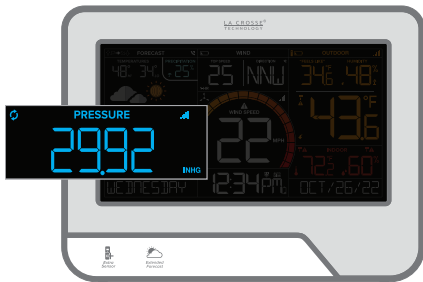

Pressure & Add-On Sensor Data

Your relative pressure and add-on sensor data share the same section on the display. Whether you choose to connect to the La Crosse View app or not, this display can show data for up to 4 extra sensors. This data will appear in the blue section on the display and in the app if connected.



Relative Pressure Example



Water Leak Sensor Example

Note: Add-on sensors are sold separately. See pages **22-24** for add-on sensor information.

Viewing Wind Data

**1. LOW BATTERY INDICATOR (🔋)**

Indicates the batteries in the Glide Pro Sensor should be replaced soon.

2. INTERNET INDICATOR (📶)

Indicates the display is receiving Wind Direction from AccuWeather.*

3. TOP WIND SPEED

Top wind speed in the past 60 minutes.

4. CURRENT WIND DIRECTION*

Choose between cardinal points (letters) or degrees in the Settings Menu.

5. HIGH WIND SPEED ALERT ICON

Appear if a wind speed alert is set & active.

6. RECEPTION INDICATOR (📶)

Indicates if the display is receiving data from the Glide Pro Sensor.

7. WIND SPEED GRAPH

Visual representation of current wind speed.

8. CURRENT WIND SPEED

Top wind speed in the past 31 seconds.

* Your display must be connected to Wi-Fi to receive wind direction data.

WIND

Wind Speed Records

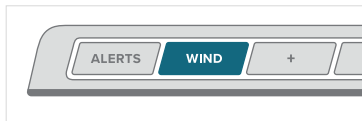

Viewing Wind Speed Records

Press the **WIND** button on the top of the display to toggle through wind speed records with time and date stamps.

This system measures high wind speed records for the past 24 hours, 7 days, 1 month, and 1 year.



24 Hour Record Example

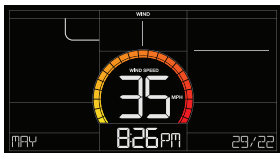

1 Month Record Example



1 Year Record Example

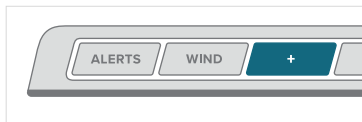

When viewing the monthly record, press the **PLUS (+)** button to toggle through the current month and past 11 months of top speed records.

Reset Wind Speed Records



Press the **WIND** button to view wind speed records.



Next, hold the **MINUS (-)** button until dashes appear on the display. This reading will now reset to the current wind value.

Viewing Temperature & Humidity Data

- THERMO-HYGR0 SENSOR ICON (i)**
Indicates Temperature readings are coming from a Thermo-Hygro Sensor.
- LOW BATTERY INDICATOR (🔋)**
Indicates the batteries in the Thermo-Hygro Sensor should be replaced soon.
- RECEPTION INDICATOR (📶)**
Indicates if the display is receiving data from a Thermo-Hygro Sensor.
- "FEELS LIKE" TEMPERATURE**
Current Heat Index or Wind Chill when conditions are met.
- OUTDOOR HUMIDITY TREND ARROWS**
Indicate humidity trend over the past 3 hours
- OUTDOOR HUMIDITY**
Current relative humidity
- OUTDOOR HUMIDITY ALERT ICONS (⚠️)**
Appear if a high (↑) or low (↓) alert is set & active.
- OUTDOOR TEMPERATURE ALERT ICONS (⚠️)**
Appear if a high (↑) or low (↓) alert is set & active.
- OUTDOOR TEMPERATURE TREND ARROWS**
Indicate temperature trend over the past 3 hours
- OUTDOOR TEMPERATURE**
Current temperature (decimal/no decimal option)
- INDOOR TEMPERATURE ALERT ICONS (⚠️)**
Appear if a high (↑) or low (↓) alert is set & active.

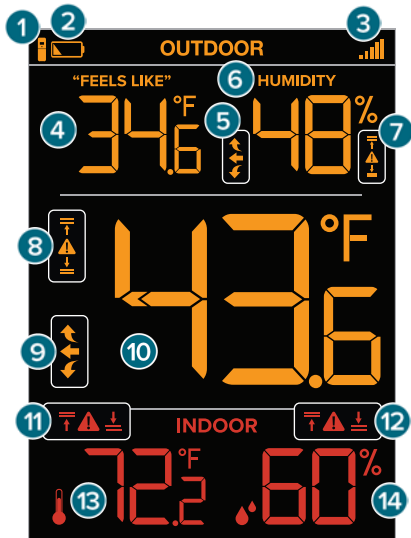

- INDOOR HUMIDITY ALERT ICONS (⚠️)**
Appear if a high (↑) or low (↓) alert is set & active.
- INDOOR TEMPERATURE**
Current temperature (decimal/no decimal option)
- INDOOR HUMIDITY**
Current relative humidity

Temperature & Humidity Records

Viewing Temperature & Humidity Records

Press the **TEMP.** button to toggle through records with time and date stamps.

Records Viewing Order

1. Outdoor High Temperature
2. Outdoor Low Temperature
3. Outdoor High Humidity
4. Outdoor Low Humidity
5. Indoor High Temperature
6. Indoor Low Temperature
7. Indoor High Humidity
8. Indoor Low Humidity
9. "Feels Like" High Temperature
10. "Feels Like" Low Temperature
11. Dew Point



High Outdoor Temperature Record Example

Reset Temperature & Humidity Records



Press the **TEMP.** button to view temperature and humidity records.



Next, hold the **MINUS (-)** button until dashes appear on the display. This reading will now reset to the current value.

"Feels Like" Temperature

This reading indicates both Wind Chill and Heat Index when conditions are met.

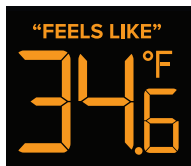

- **Wind Chill:** When temperature is below 50°F (10°C) and there is 5 MPH (8 KPH) of sustained wind speed.
- **Heat Index:** When temperature is above 80°F (27°C).
- **Current Temperature** When the temperature is between 50°F and 80°F (10.5°C and 26.1°C), the readings will remain the same as the outdoor value regardless of wind speed.

ALERTS

Customizable Alerts

Setting Custom Alerts

1. Hold the **ALERTS** button to enter the Alert Settings Menu.
2. Use the **+/-** buttons to activate/deactivate individual alerts, or press the **ALERTS** button to skip to the next option.
3. Once activated, use the **+/-** buttons to adjust the values. Press the **ALERTS** button to confirm and move forward.

Alert Setting Order

1. High Wind Speed
2. Outdoor High Temperature
3. Outdoor Low Temperature
4. Outdoor High Humidity
5. Outdoor Low Humidity
6. Indoor High Temperature
7. Indoor Low Temperature
8. Indoor High Humidity
9. Indoor Low Humidity

Activating/Deactivating Alerts



Hold the **ALERTS** button to enter alert settings.



Use the **+/-** buttons to activate/deactivate alerts.

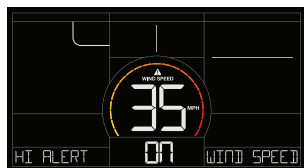

High Wind Speed Alert Example

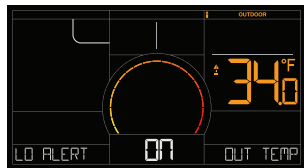

Outdoor Low Temperature Alert Example

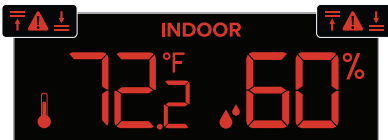

Active alerts are indicated by the ▲ and ▼/▲ icons located in their respective sections on the LCD.

Triggered Alerts

- When an alert value is reached, the corresponding value and alert icon will flash on screen.
- The display will also beep 5 times each minute until the value moves out of the alert range. Press any button to stop the alert sound.
- Alerts set on the display are separate from those created within the La Crosse View app.

Sensor Placement & Mounting

For Accurate Glide Pro Sensor Measurements

- For optimal battery life, ensure the Solar Panel is facing south.
- Ideally, the Glide Pro Sensor should be mounted on the tallest object in your area. Avoid positioning the sensor parallel or below eaves, roof lines, trees, or other objects that may obstruct wind speed readings.
- Make sure the screws on the Wind Cups and Mounting Bracket are securely fastened.
- The maximum wireless transmission range to the display is up to 400 feet (121.92 m) in open air, not including walls or floors.
- The Glide Pro Sensor should be mounted with the Wind Cups on the top.



For Accurate Thermo-Hygro Sensor Measurements

- Insert a mounting screw through the hole at the top to securely mount the sensor. It can also hang from the back using a nail.
- Mount the sensor vertically in a protected well-shaded area. Keeping it out of direct weather elements such as sunlight, rain, snow, etc. will help avoid inaccurate readings.
- The maximum wireless transmission range to the display is up to 400 feet (121.92 m.) in open air, not including walls or floors.
- For additional protection against weather elements, a Sensor Weather Shield (bit.ly/weather-shield) is available for purchase.
- For video instructions, visit: bit.ly/th_sensor_mounting

Glide Pro Sensor Mounting

Fence posts, poles, decks, and mailboxes are common mounting options due to their convenience. Many users prefer these types of locations as the data they provide is accurate from their ground level perspective. However, because the wind in these spots is often affected by obstructions, the readings may differ when compared to local reporting stations.

Basic Installation

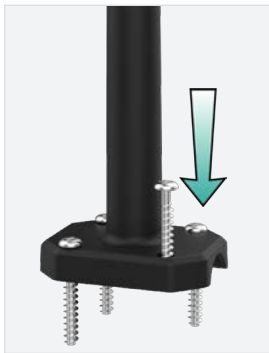

Mount the Mast to a flat surface with the four provided screws.



Place the Glide Pro Sensor on top of the Mast. Ensure the Solar Panel is facing south.

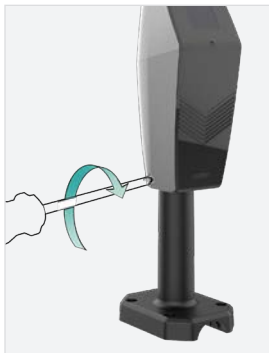

Secure the Glide Pro Sensor to the Mast by tightening the screws on the side.

If the basic installation option detailed above isn't suitable for your location, the Glide Pro Sensor is designed to work in a variety of configurations. See the next page for details regarding flexible and advanced installation options.

Glide Pro Sensor Mounting

Flexible Installation

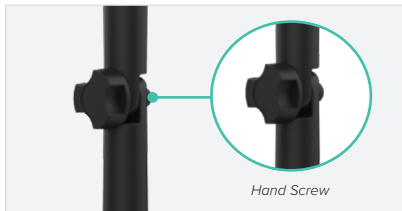

Install the Hand Screw to the bracket, then secure the Glide Pro Sensor to the Mast by tightening the screws on the side.



This configuration allows you to attach the sensor to angled locations and easily make adjustments to ensure the sensor is mounted properly.

Advanced Installation

Some advanced installation options include tripods, wall mounts, and chimney mounts. Any of these can be combined with U-bolts for attachment onto a tall cylindrical conduit using the Adjustable Base. These options will require additional equipment and possibly professional help for best results.



Freestanding Pole Setup

1" Maximum Outside Pole Diameter



Tripod Setup Example

1" Maximum Outside Pole Diameter

SENSORS

Featured Add-On Sensors



RAIN SENSOR

FEATURES INCLUDE:

Current Rainfall
Rainfall Records

BBQ SENSOR

FEATURES INCLUDE:

Two Hi-Temperature Probes
Backlit Display & Storage Case

POOL SENSOR

FEATURES INCLUDE:

Water Temperature
Floating Design with LCD Display

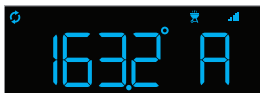
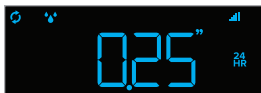

Display & App Screenshots
Featured: LTV-R3

Display & App Screenshots
Featured: LTV-BBQ1

Display & App Screenshots
Featured: LTV-POOLV2

USE CASE: Check rain totals from last night's storm to help make adjustments to your lawn & garden watering schedule.

USE CASE: Set independent timers and alerts to monitor two steaks at the same time.

USE CASE: Place in a pool or hot tub to keep an eye on changes in water temperature.

SENSORS

Featured Add-On Sensors



MULTI-SENSORS

FEATURES MAY INCLUDE:

Wind Speed, Direction, Rainfall, Temperature, and Humidity



THERMO-HYGRO SENSORS

FEATURES MAY INCLUDE:

Temperature & Humidity
LCD Display

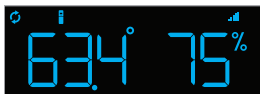

WATER LEAK SENSOR

FEATURES INCLUDE:

Water Detection
Ambient Temperature

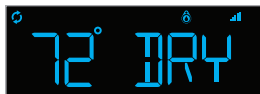

Display & App Screenshots

Featured: LTV-WSDTH04 & LTV-WSDR1



Display & App Screenshots

Featured: LTV-TH1 & LTV-TH2

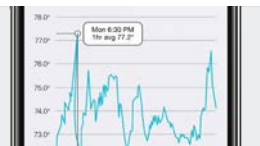

Display & App Screenshots

Featured: LTV-WL1



Expand Your System to Suit Your Needs

Find more add-on sensor options by scanning the QR code or visiting: bit.ly/v23_parts

Add-On Sensors

Adding Sensors to Your Display

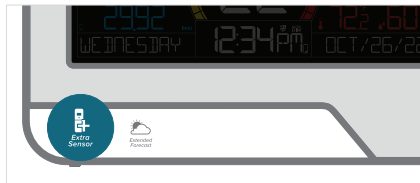

1. Hold the **EXTRA SENSOR** (E S) button until the Sensor Reception Indicator (📶) starts to animate.



Inside of Water Leak Sensor*



Top of Water Leak Sensor*

2. Install batteries into your sensor. If the sensor has a **TX** button, press it to force a transmission signal. This button is usually located in or near the sensor's battery compartment. The LED light on the sensor will flash once.
3. Your sensor should connect within the next three minutes. The Sensor Reception Indicator (📶) will appear solid when a sensor is connected.

* Water Leak Sensor shown as example, sensor not included

Viewing Add-On Sensor Data

Tap the **EXTRA SENSOR** (E S) button to switch between pressure and add-on sensor readings, or select the Auto-Scroll option to cycle through all available pressure and sensor data.

Programming the Auto-Scroll Option



Tap the **EXTRA SENSOR** (E S) button until **AUTOSCROLL** appears on the display.



The Auto-Scroll Icon (🔄) located in the top left corner will appear when active.

To deactivate the Auto-Scroll option, tap the **EXTRA SENSOR** (E S) button until the Auto-Scroll Icon (🔄) disappears. The display will stay on your current selection.

Specifications

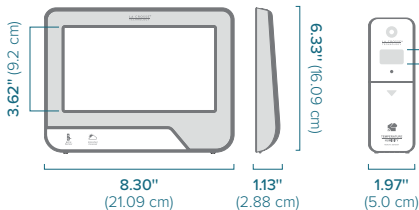

DISPLAY (V23)

- **Indoor Temp. Range:** 32°F to 122°F (0°C to 50°C)
- **Indoor Humidity Range:** 10 to 99%RH
- **Power Requirements:** 5.0V Adapter (included) + Battery Backup: 1 "CR2032" Coin Cell Battery (included) *Saves time/date when unplugged*

The plug on the power adapter is intended to serve as the disconnect device, the socket-outlet shall be installed near the equipment and shall be easily accessible.

- **LCD Brightness:** 4 Intensity Levels + OFF (Programmable Auto-Dim Backlight Option)
- **Languages:** English, Spanish, French, & German (Translations Available for Menus and Calendar)

Wi-Fi NETWORK REQUIREMENTS

- **Broadcast Frequency:** 2.4GHz (802.11 b/g/n)
- **Name/Password:** Must Not Exceed 45 Characters
- **Network Speed:** Must Be Greater than 1 Mbps

Note: If you have a multi-band router, this device will connect to the **2.4GHz** band when connecting to Wi-Fi.

Apple and the Apple logo are trademarks of Apple Inc., registered in the U.S. & other countries. App Store is a service mark of Apple Inc. Google Play and the Google Play logo are trademarks of Google Inc.

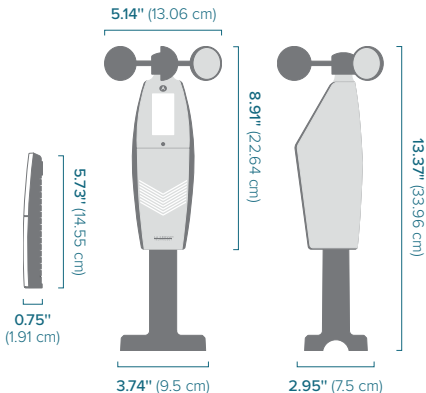

THERMO-HYGRO SENSOR (LTV-TH2i)

- **Outdoor Temp. Range:** -40°F to 140°F (-40°C to 60°C)
- **Outdoor Humidity Range:** 10 to 99%RH
- **Transmission Range:** 400 feet (121.92 m) open air
- **Update Interval:** Every 51 Seconds
- **Power Requirements:** 2 "AA" Batteries (not included)
- **Battery Life:** Over 24 Months

GLIDE PRO SENSOR (LTV-W3)

- **Wind Speed Range:** 0 to 111 mph (0 to 178 kph)
- **Transmission Range:** 400 feet (121.92 m) open air
- **Update Interval:** Every 31 Seconds
- **Power Requirements:** 3 "AA" Batteries (not included)
- **Battery Life:** Over 36 Months

MOBILE REQUIREMENTS

- Apple phones require iOS with cellular or Wi-Fi service.
- Android phones require Android OS with cellular or Wi-Fi service.

Coin Cell Battery

Replace the Coin Cell Battery

1. Use a coin to turn the battery cover to the left to remove it.
2. Pull back the metal pin and gently remove the battery.
3. Insert a fresh CR2032 battery with the + side up and snap it into place.
4. Replace the battery cover and use the coin to turn it to the right to lock.

Battery Replacement Instructions

When batteries of different brand or type are used together, or new and old batteries are used together, some batteries may be over-discharged due to a difference of voltage or capacity. This can result in venting, leakage, and rupture and may cause personal injury.

- Do not mix Alkaline, lithium, standard, or rechargeable batteries.
- Always purchase the correct size and grade of battery most suitable for the intended use.
- Always replace the whole set of batteries at one time, taking care not to mix old and new ones, or batteries of different types.
- Clean the battery contacts and also those of the device prior to battery installation.
- Ensure the batteries are installed correctly with regard to polarity (+ and -).
- Remove batteries from product during periods of non-use. Battery leakage can cause corrosion and damage to this product.
- Remove used batteries promptly.
- For recycling and disposal of batteries, and to protect the environment, please check the internet or your local phone directory for local recycling centers and/or follow local government regulations.

WARNING

1. This product contains a coin cell battery.
2. If swallowed, it could cause severe injury or death in just 2 hours.
3. Seek medical attention immediately.

WARNING: KEEP BATTERIES OUT OF REACH OF CHILDREN

1. Swallowing may lead to serious injury in as little as 2 hours or death, due to chemical burns and potential perforation of the esophagus.
2. If you suspect your child has swallowed or inserted a coin cell battery, immediately seek urgent medical assistance.
3. Examine devices and make sure the battery compartment is correctly secured, e.g. that the screw or other mechanical fastener is tightened.
4. Do not use if compartment is not secure.
5. Dispose of used coin cell batteries immediately and safely.
6. Flat batteries can still be dangerous.
7. Tell others about the risk associated with coin cell batteries and how to keep their children safe.

California Residents

 **WARNING:** This product can expose you to chemicals including acrylonitrile, butadiene, and styrene, which are known to the State of California to cause cancer and birth defects or other reproductive harm.

For more information, go to: www.P65Warnings.ca.gov

The manufacturer is not responsible for any radio or TV interference caused by unauthorized changes or modifications to this equipment. Such changes or modifications could void the user authority to operate the equipment.

All rights reserved. This manual may not be reproduced in any form, even in part, or duplicated or processed using electronic, mechanical or chemical process without the written permission of the publisher.

This booklet may contain errors or misprints. The information it contains is regularly checked and corrections are included in subsequent editions. We disclaim any responsibility for any technical error or printing error, or their consequences. All trademarks and patents are recognized.



WARNING: CHOKING HAZARD—Small Parts

Not for children under 3 yrs.

FCC Statement

This equipment has been tested and found to comply with the limits for a Class B digital device, pursuant to part 15 of the FCC Rules. These limits are designed to provide reasonable protection against harmful interference in a residential installation.

This equipment generates, uses and can radiate radio frequency energy and, if not installed and used in accordance with the instructions, may cause harmful interference to radio communications. However, there is no guarantee that interference will not occur in a particular installation. If this equipment does cause harmful interference to radio or television reception, which can be determined by turning the equipment off and on, the user is encouraged to try to correct the interference by one or more of the following measures:

- Reorient or relocate the receiving antenna.
- Connect the equipment into an outlet on a circuit different from that to which the receiver is connected.
- Increase the separation between the equipment and receiver.
- Consult the dealer or an experienced radio/TV technician for help.

FCC Radiation Exposure Statement

This device complies with FCC radiation exposure limits set forth for an uncontrolled environment and it also complies with Part 15 of the FCC RF Rules. This equipment must be installed and operated in accordance with provided instructions and the antenna(s) used for this transmitter must be installed to provide a separation distance of at least 20 cm from all persons and must not be co-located or operating in conjunction with any other antenna or transmitter. End-users and installers must be provided with antenna installation instructions and consider removing the no-collocation statement.

This device complies with Part 15 of the FCC Rules.

Operation is subject to the following two conditions:

- (1) This device may not cause harmful interference, and
- (2) This device must accept any interference received, including interference that may cause undesired operation.

Caution: Any changes or modifications not expressly approved by the party responsible for compliance could void the user's authority to operate the equipment.

Canada Statement

This device contains licence-exempt transmitter(s)/receiver(s) that comply with Innovation, Science and Economic Development Canada's licence-exempt RSS(s). Operation is subject to the following two conditions: (1) This device may not cause interference; and (2) This device must accept any interference, including interference that may cause undesired operation of the device.

The device meets the exemption from the routine evaluation limits in section 2.5 of RSS 102 and compliance with RSS-102 RF exposure, users can obtain Canadian information on RF exposure and compliance. This transmitter must not be co-located or operating in conjunction with any other antenna or transmitter. This equipment should be installed and operated with a minimum distance of 20 centimeters between the radiator and your body.

Having Trouble? We're here to help.

Use the links below to find additional resources or reach out to our staff directly.

Self-Help: bit.ly/v23_support • Online: bit.ly/contact_techsupport

Phone: **1.844.200.8752**

Representatives are available Monday-Friday, 8am-6pm CST



Scan for Additional
Info and Support

Warranty

La Crosse Technology, Ltd. provides a 1-year limited time warranty (from date of purchase) on this product, relating to manufacturing defects in materials and workmanship.

For full warranty details, visit:

www.lacrossetechnology.com/pages/warranty

La Crosse Technology, Ltd.

2830 South 26th Street, La Crosse, Wisconsin 54601

Recycling & Disposal

Please consider the environment when deciding to dispose of this product. Although household electronics are generally safe to use on a daily basis, incorrect disposal can cause negative and potentially irreversible impacts on our environment.

Check with local donation centers to see if your product can be donated for future use. If disposal is the only option, federal agencies, local governments, and certified retailers may have electronic recycling programs in place. Programs may vary based on location.

Factory Reset



If you are experiencing issues, press the **ALERTS & LIGHT** buttons down together until the display beeps. You do not need to remove the battery to reset the display. All records will be lost when a factory reset is performed.

Stay in Touch

Ask questions, watch setup videos, and provide feedback on our social media outlets.



Follow La Crosse Technology on Facebook, Instagram, YouTube, and Twitter.