

LA CROSSE<sup>®</sup>  
TECHNOLOGY

# Breeze Sensor



MODEL: TX145WSDTHv3

## REPLACEMENT SENSOR - STATION CONNECTION

For users setting this up as a replacement sensor, follow these steps to get it synced with your display:

1. Hold the WIND button on your station to search for the new sensor. The Reception Icon  will begin to animate, indicating it is searching for a new sensor connection.
2. Install 3 new AA alkaline batteries into the Breeze Sensor (as shown below).
3. Keep the sensor near the display and allow 5 minutes for the sensor readings to appear.

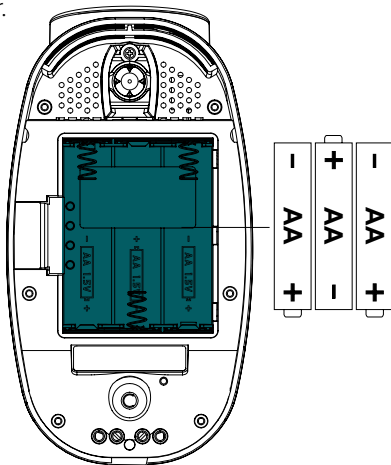

# MOUNTING



## For Accurate Measurements

- Ensure the sensor is mounted level with the Solar Panel facing directly to the south. This will help optimize battery life and transmit correct wind direction readings.
- Ideally, the Breeze Sensor should be mounted on the tallest object in your area. Avoid positioning the sensor in line or below eaves, rooflines, trees, or other objects that may obstruct wind readings.
- Make sure all screws on the Mounting Bracket, Winds Cups, Wind Vane, and Battery Compartment are securely fastened.
- The sensor should be mounted with the Wind Cups on top.

## Included Mounting Accessories

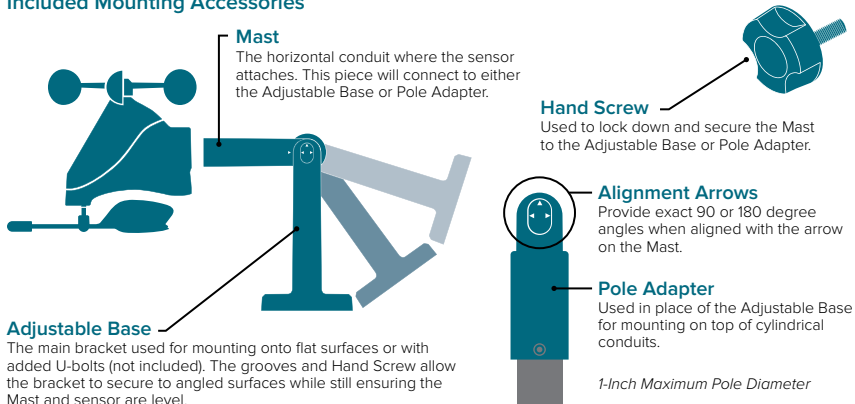

# INSTALLATION OPTIONS

## Basic Assembly

Fence posts, poles, decks, and even mailboxes are all common mounting options due to their convenience. Many users prefer these types of locations as the data they provide is accurate from their ground level perspective. However, because wind in these spots is often affected by obstructions, the readings may differ compared to local reporting stations.



1A Adjustable Base

## For Accurate Measurements

- 1A. Mount the Adjustable Base onto a flat surface using the four long screws provided.
- 1B. Secure the Pole Adapter to a cylindrical conduit using the two smaller screws provided.
2. Insert the Mast into the Breeze Pro Sensor and tighten the provided screws on the sides.
3. Use the Hand Screw to attach the Mast to either the Adjustable Base or Pole Adapter. Ensure the sensor is level, facing south, and securely fastened at all mounting points.

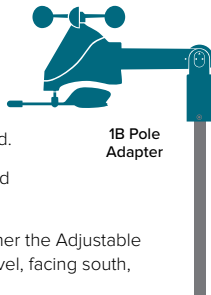

1B Pole Adapter

## Advanced Installation Options

Some advanced installation options include tripods, wall mounts, eave cross mounts, chimney mounts, and many others. Any of these can be combined with U-bolts for attachment onto a tall cylindrical conduit using our Adjustable Base. Please note that these advanced options will require additional equipment and possibly professional help for best results.

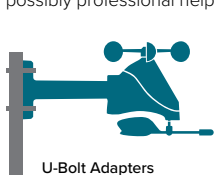

U-Bolt Adapters

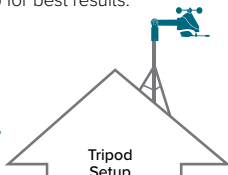

Tripod Setup

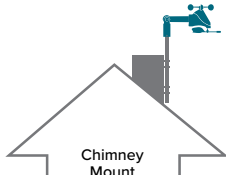

Chimney Mount

*The illustrations above are not to scale and are for informative purposes only. La Crosse Technology is not responsible for any damages or injury that may occur during installation.*

# BREEZE SENSOR SPECIFICATIONS (TX145WSDTHv3)

- **Wind Speed Range:** 0 to 111 mph (0 to 178 km/h)
- **Degrees of Wind Direction:** 360° with 16 Cardinal Directions
- **Outdoor Temp. Range:** -40°F to 140°F (-40°C to 60°C)
- **Outdoor Humidity Range:** 10 to 99%RH
- **Transmission Range:** 400 Feet (121.92 Meters)
- **Power Requirements:** 3 "AA" batteries
- **Update Interval:** Every 31 Seconds
- **Sensor Dimensions:** 11.97 in. L x 7.94 in. W x 9.76 in. H (30.40 cm L x 20.17 cm W x 24.79 cm H)

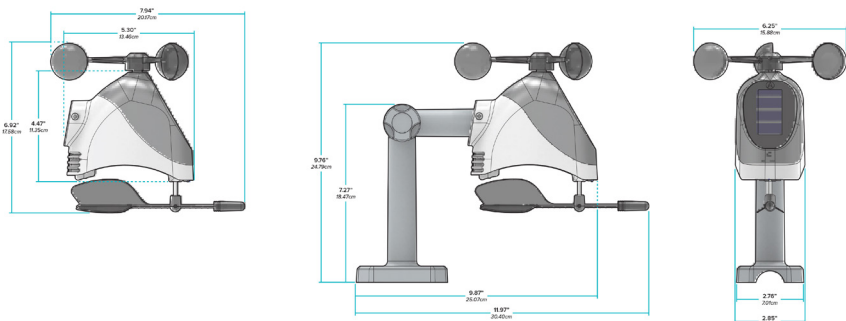

## CARE & MAINTENANCE

- Do not mix old and new batteries.
- Always purchase the correct size and grade of battery suitable for intended use.
- Ensure the batteries have with correct polarity (+/-).
- Promptly remove expired batteries.
- Do not mix Alkaline, Lithium, standard, or rechargeable batteries.
- Clean the battery contacts and also those of the device prior to battery installation.
- Remove batteries from equipment that will not to be used for an extended period.

## WARRANTY INFO

La Crosse Technology, Ltd. provides a **1-year limited time warranty** (from date of purchase) on this product relating to manufacturing defects in materials & workmanship. La Crosse Technology, Ltd, 2830 S. 26th St., La Crosse, WI 54601

**For Full Warranty Details, Visit:** [www.lacrossetechnology.com/pages/warranty](http://www.lacrossetechnology.com/pages/warranty)

**Patents:** [www.lacrossetechnology.com/patents](http://www.lacrossetechnology.com/patents)

## FCC STATEMENT

This equipment has been tested and found to comply with the limits for a Class B digital device, pursuant to part 15 of the FCC Rules. These limits are designed to provide reasonable protection against harmful interference in a residential installation.

This equipment generates, uses and can radiate radio frequency energy and, if not installed and used in accordance with the instructions, may cause harmful interference to radio communications. However, there is no guarantee that interference will not occur in a particular installation. If this equipment does cause harmful interference to radio or television reception, which can be determined by turning the equipment off and on, the user is encouraged to try to correct the interference by one or more of the following measures:

- Reorient or relocate the receiving antenna.
- Increase the separation between the equipment and receiver.
- Connect the equipment into an outlet on a circuit different from that to which the receiver is connected.
- Consult the dealer or an experienced radio/TV technician for help.

This device complies with Part 15 of the FCC Rules. Operation is subject to the following two conditions:

- (1) This device may not cause harmful interference, and
- (2) This device must accept any interference received, including interference that may cause undesired operation.

## CAUTION!

Any changes or modifications not expressly approved by the party responsible for compliance could void the user's authority to operate the equipment.

All rights reserved. This manual may not be reproduced in any form, even in part, or duplicated or processed using electronic, mechanical or chemical process without the written permission of the publisher.

This booklet may contain errors or misprints. The information it contains is regularly checked and corrections are included in subsequent editions. We disclaim any responsibility for any technical error or printing error, or their consequences. All trademarks and patents are recognized.



## CA WARNING:

This product can expose you to chemicals including acrylonitrile, butadiene, and styrene, which are known to the State of California to cause cancer and birth defects or other reproductive harm. For more information, go to: [www.P65Warnings.gov](http://www.P65Warnings.gov)