

LA CROSSE®
TECHNOLOGY

Color Wind Speed Weather Station



For online video support:
<http://bit.ly/LaxTechTalk>

Instructional Manual

Model: 327-1417v2 DC:012819

Contents

Setup Preparation	3	Weather Forecast Icons	11
Quick Setup	3	Forecast Trend Arrows	11
Buttons	4	Backlight Adjustments	11
Settings	4	Change Batteries	12
Atomic Time	5	Sensor Search	12
DST Definition	5	Connect Add-on Sensors to Station .	13
Display Icons	6	View Channels	13
Wind Speed Graph	6	Mounting TX141TH-BCH Sensor	14
Wind Readings	7	Mounting TX144W Wind Sensor	14
Wind History	7	Position Weather Station	15
Reset Wind Speed History	8	Replace Wind Cups	15
Temperature/Humidity HI LO Readings ..	8	Factory Reset Clear Memory	15
Reset Temperature/Humidity Readings ...	9	Visit Us on Social Media	16
Set Weather Alerts	9	Care and Maintenance	16
Weather Alerts	9	Specifications	17
Active Alert	10	Warranty and Support	18
Temperature/ Humidity Trend Arrows ..	10	FCC Statement	18
		Canada Statement	18

Setup Preparation

Items you will need to setup your station (not included):

1. Phillips head screwdriver for assembly.
2. Fresh Batteries:
 - 3 (three) AA alkaline batteries for the station (optional)
 - 2 (two) AA alkaline or lithium batteries for the TH sensor.
 - 2 (two) C alkaline or lithium batteries for the Wind sensor.

For best results:

- Remove weather station and sensors from the package and place together on a table or bench, within easy reach.
- Place batteries and screwdriver within reach of setup location.
- Keep sensors and weather station within 5-10 feet for at least 15 minutes after installing batteries. This allows the sensors and station to sync properly and ensures a strong connection.

Quick Setup

1. Power up: Select channel 1 on the outdoor Thermo-hygro sensor then insert 2-AA batteries. Insert 2-C batteries into the Wind sensor. Insert the power cable into the weather station.
2. Configure basic settings. Set Time, Date etc.
3. After 15 minutes, place sensors outside (see mounting instructions on [page 14](#)).
Optional: insert 3-AA batteries into the weather station.

Thermo-hygro sensor
TX141TH-BCHv3

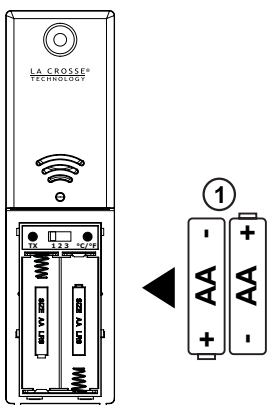

Wind Speed sensor
TX144W

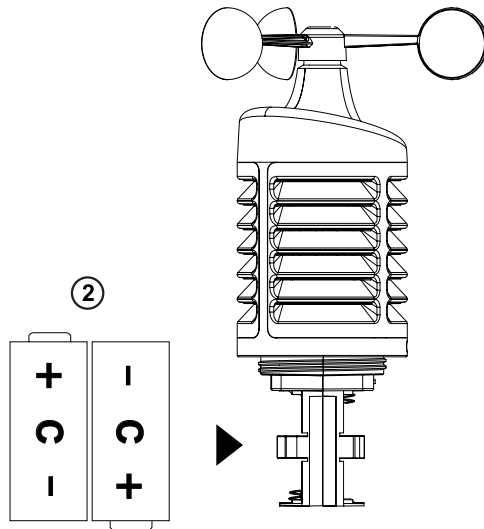

Weather Station
327-1417v2

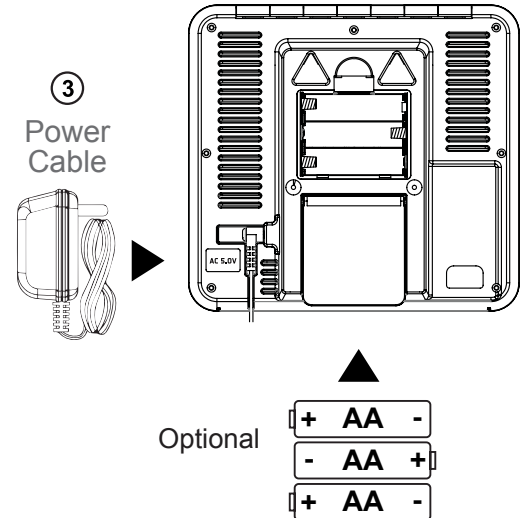

Note: Batteries are not included

Red LED on sensors: Both sensors have a red LED light that flashes once during sensor signal transmission.

Buttons

- Buttons are located on the top of the weather station.
- When entering a settings mode, **hold** the correct button (SET, ALERTS).
- And press and release the correct SET or ALERT button again to move to the next item in that setting mode.
- Press and release the +/- buttons to change a setting.
- Press and release the correct button to view readings (Wind, or Temp/Humidity).

ALERTS	TEMP	WIND	+	- / CH	SET	LIGHT
--------	------	------	---	--------	-----	-------

Settings

1. Hold the **SET** button for 3 seconds to enter time set mode.
2. Press and release the **+** or **-/CH** buttons to adjust the values. Hold to adjust quickly.
3. Press and release the **SET** button to confirm and move to the next item.

Note: Press and release the **LIGHT** button any time to exit settings.

Settings order:

1. BEEP ON | OFF
2. ATOMIC ON | OFF
3. Time Zone
4. DST ON/OFF
(Daylight Saving Time)
5. 12h/24h hour format
6. Hour
7. Minutes
8. Year
9. Month
10. Date
11. Temperature (C/F)
12. Wind speed select (mph/kmh)

Note: Setting the time zone for your location assures the time will be correct.

Time-zone will be displayed as:

- AST: Atlantic Standard Time
- EST: Eastern Standard Time
- CST: Central Standard Time
- MST: Mountain Standard Time
- PST: Pacific Standard Time
- AKT: Alaska Standard Time
- HAT: Hawaii-Aleutian Standard Time

Note: Press only one button at a time while in the settings menu.

To begin: Hold the **SET** button 3 seconds, then release:

1. BEEP ON | OFF

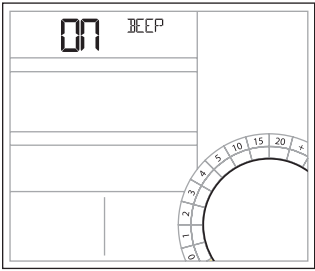

2. ATOMIC ON | OFF

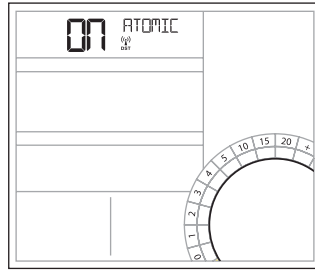

3. Time Zone

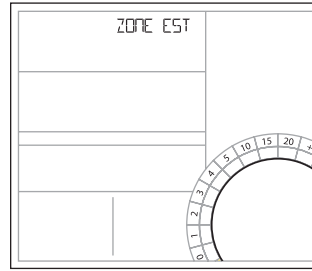

4. DST ON | OFF

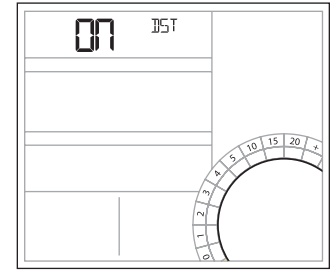

5. 12 | 24 Format

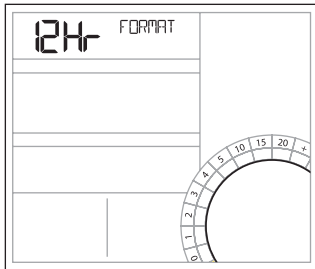

6. Hour

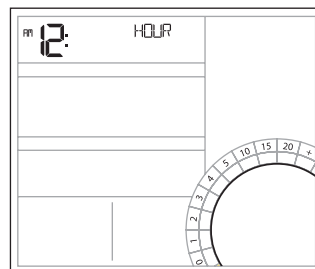

7. Minutes

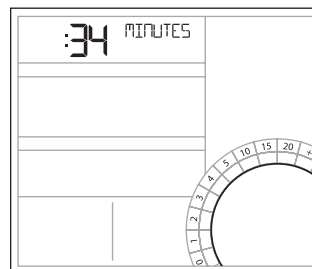

8. Year

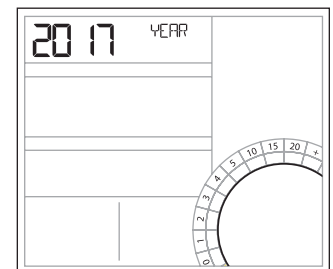

9. Month

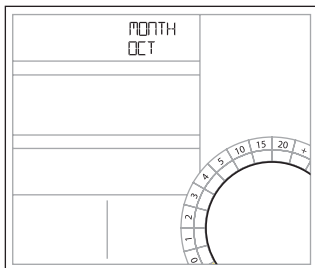

10. Date

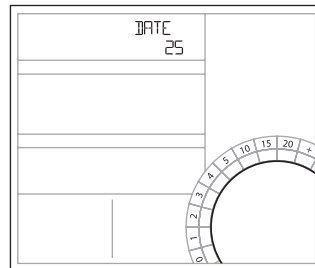

11. Fahrenheit | Celsius

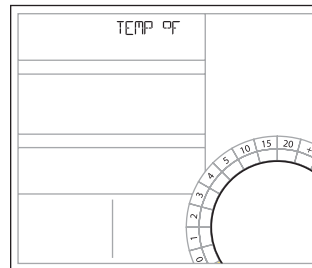

12. MPH | KMH

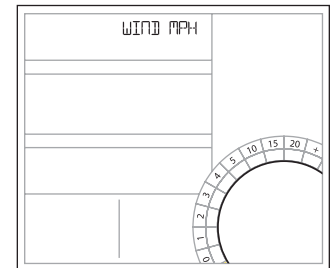

Note: The day of the week is set automatically, after Year, Month, and date are specified

- Press the LIGHT button at any time to exit.
- After 20 seconds with no button press, the station will default back to normal time display.

DST Definition

- The letters DST below the Atomic Tower icon will show when observing Daylight Saving Time and disappear when observing Standard Time.
- When DST is on, time will adjust automatically according to the DST definition.



DST definition: DST begins at 2:00 am on the 2nd Sunday in March and ends the 1st Sunday in November

Atomic Time

- The station will search for the atomic time signal at UTC 7:00, 8:00, 9:00, 10:00, and 11:00.
- Press and release the SET button to search manually for atomic time signal.
- For information about WWVB visit: <http://bit.ly/AtomicTime>

Display Icons

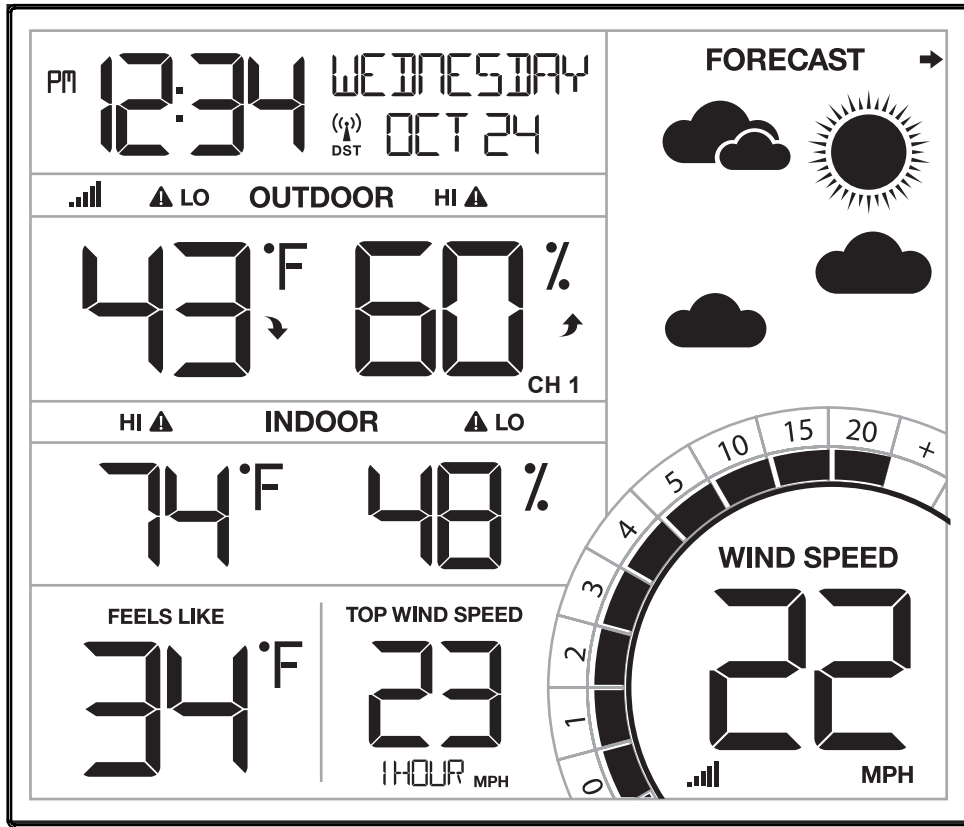

AM PM AM | PM

 Forecast Icon

 Atomic Time

% Percent Humidity

DST Daylight Saving Time

 HI | LO Alert

 Sensor Strength

KMH MPH Kilometers | Miles per hour

°F °C Fahrenheit | Celsius

CH 1 Channel Indicator

 Trend Arrows

Wind Speed Graph

- Wind speed chart will fill to current speed. Current speed will blink.
Example: 16 mph wind will show filled sections to 10 mph, and 15 mph color segment will flash.
- The units (MPH/KMH) are setup in the settings menu.

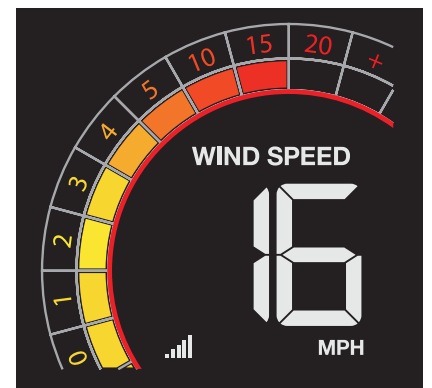

Wind Readings

Wind Speed: Highest speed in past 30 seconds

Top Wind Speed: Highest recorded wind speed in time interval. Default is 1 hour, controlled by the Wind History feature, details below.

Feels Like Temperature:

Wind Speed | Temperature | Humidity combined

- When outdoor temp is higher than 80°F, displays heat index
- When outdoor temp is lower than 50°F, displays wind chill
- When outside of the above ranges will display current outdoor temperature.

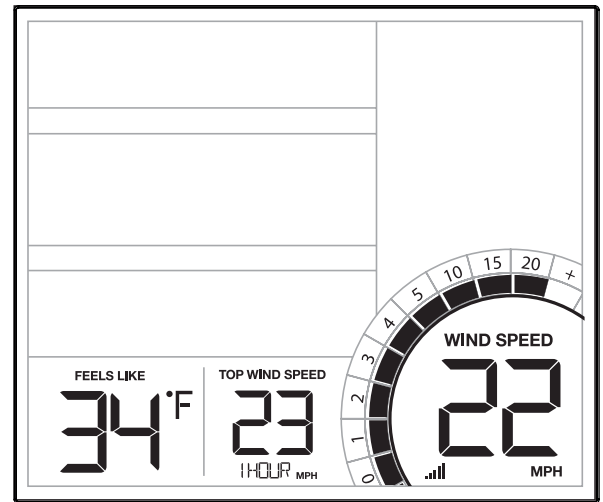

Wind History

Press and release the WIND button to view the maximum wind history values.

- One Hour: past 60 minute period (default Top Speed record, already shown)
- 24 hour: Past 24 hour period, from last record
- 7 Days: Past 7-day period, from last record
- Month: Defined by Calendar Month i.e. January 1 - January 31
- Year: Defined by Calendar Year i.e. January 1 - December 31

Note: After 5 seconds all readings default back to the 1 hour top wind speed.

24 Hours

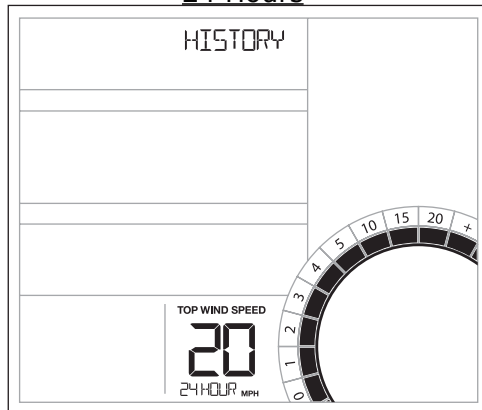

7 Days

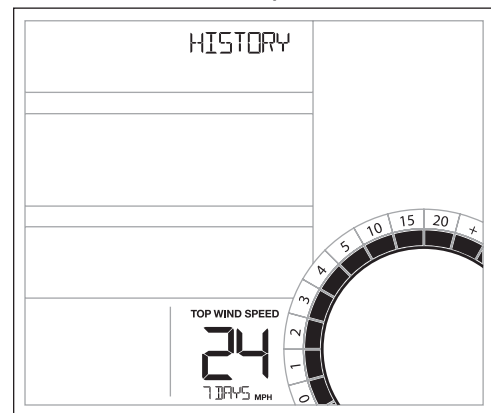

Month

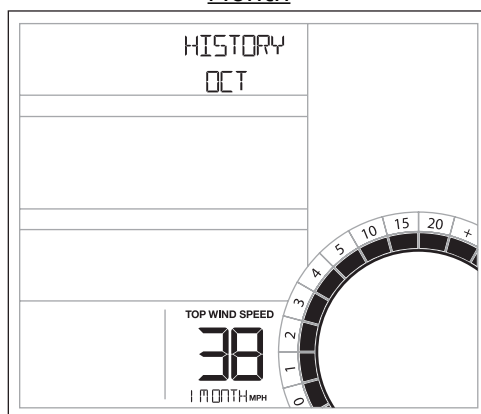

Year

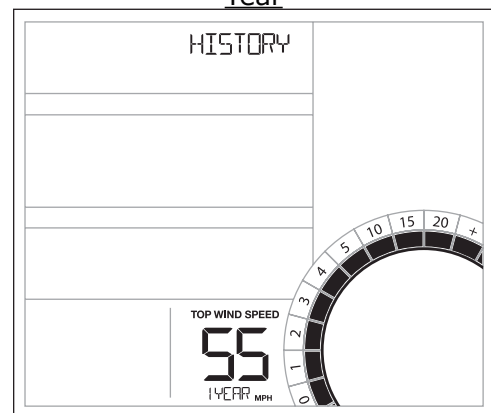

Reset Wind Speed History

- Press the WIND button to view individual wind speed readings.
- Hold the MINUS button for five seconds to reset **each individual** value.
- Wind speed reading will reset to current wind speed.

Temperature/Humidity HI | LO Readings

Press and release the TEMP button to view HI/LO temperature and humidity readings with time/date stamp. Press and release TEMP again to view the next value.

- Outdoor temperature HIGH
- Outdoor temperature LOW
- Outdoor humidity HIGH
- Outdoor humidity LOW
- Indoor temperature HIGH
- Indoor temperature LOW
- Indoor humidity HIGH
- Indoor humidity LOW
- Feels like HIGH
- Feels Like LOW
- Dew Point

Note: Dew Point Temperature is not time/date stamped.

Outdoor Temp HI

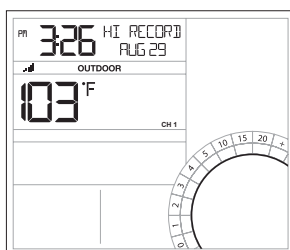

Outdoor Temp LO

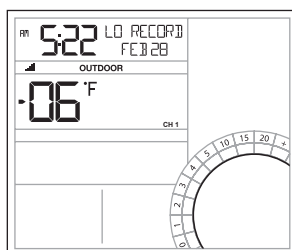

Outdoor Humidity HI

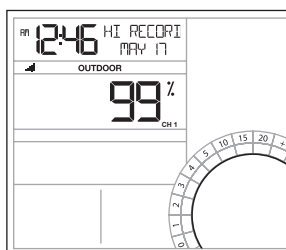

Outdoor Humidity LO

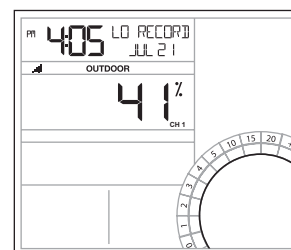

Indoor Temp HI

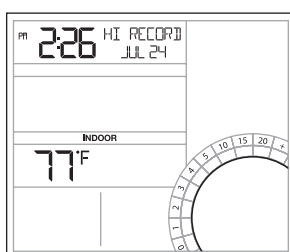

Indoor Temp LO

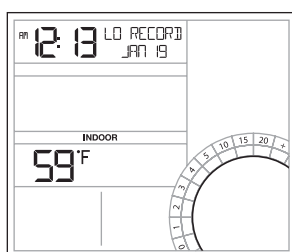

Indoor Humidity HI

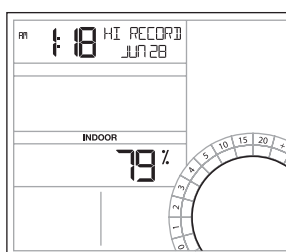

Indoor Humidity LO

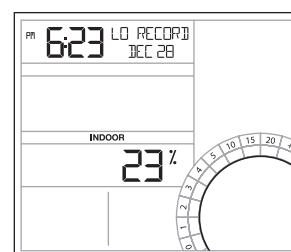

Feels Like HI

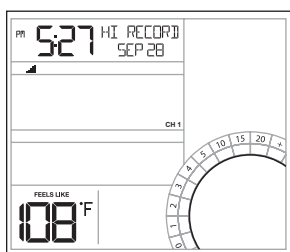

Feels Like LO

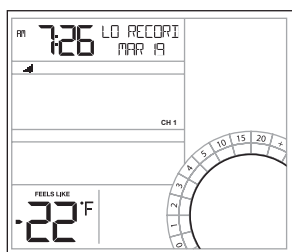

Dew Point

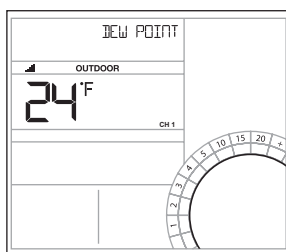

Reset Temperature/Humidity Readings:

- Press the TEMP button to view individual HI | LO readings.
- Hold the MINUS button for five seconds to reset **each individual** value.
- Individual readings will reset to current temperature, humidity, etc.

Set Weather Alerts

- Hold the ALERTS button for 3 seconds to enter alert set mode.
- High Wind Speed ON | OFF will flash.

Alert ON:

1. Press the +/- buttons to arm the alert.
2. Press the ALERTS button and the alert value will flash
3. Press the +/- buttons to set the alert value (Hold to set quickly).
4. Press ALERTS button to move to next alert.

Alert OFF:

1. Alerts are OFF unless armed. If you do not wish to set an alert, simply press the ALERTS button again to move to the next alert.

Alert OFF use +/- to arm (turn on)

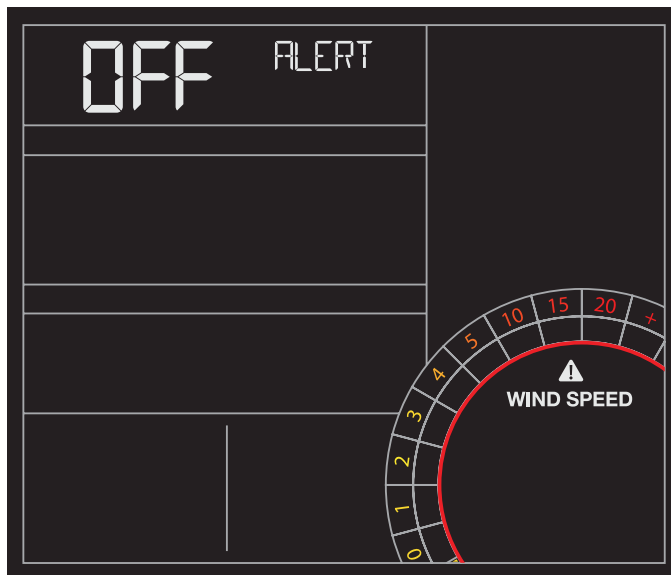

Alert ON use +/- to set value

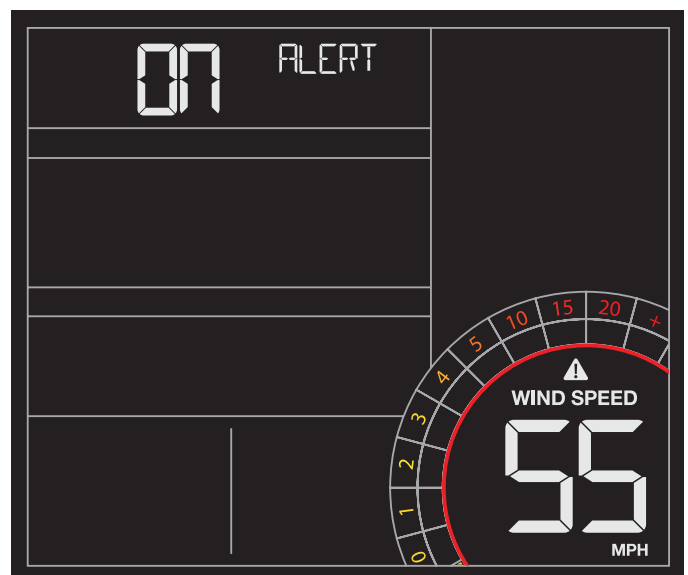

Weather Alerts

Here is the setting order for the 9 programmable alerts.

- High Wind Speed ON/OFF (CURRENT wind)
- High Wind Speed Value 0-99mph (0-159kph)

- Outdoor LOW Temperature ON/OFF
- Outdoor LOW Temperature Value -40°F to 140°F (-40°C to 60°C)
- Outdoor HIGH Temperature ON/OFF
- Outdoor HIGH Temperature Value -40°F to 140°F (-40°C to 60°C)

- Outdoor LOW Humidity ON/OFF
- Outdoor LOW Humidity Value 10%RH to 99%RH
- Outdoor HIGH Humidity ON/OFF
- Outdoor HIGH Humidity Value 10%RH to 99%RH

- Indoor LOW Temperature ON/OFF
- Indoor LOW Temperature Value 32°F to 99°F (0°C to 37°C)
- Indoor HIGH Temperature ON/OFF
- Indoor HIGH Temperature Value 32°F-99°F (0°C to 37°C)

- Indoor LOW Humidity ON/OFF
- Indoor LOW Humidity Value 10%RH to 99%RH
- Indoor HIGH Humidity ON/OFF
- Indoor HIGH Humidity Value 10%RH to 99%RH

Active Alert

- When armed alert value is reached, station will beep 5 times each minute, until out of alert range.
- The flashing alert icon will indicate which alert is sounding.
- Press any button to stop the alert sound.
- The alert icon will flash while value is in alert range.

HI  LO

Disarm Alert:

1. Hold the ALERTS button for 3 seconds to enter alert set mode.
2. Press and release ALERTS button until you see the alert you wish to disarm.
3. Press the +/- buttons to disarm the alert.
4. Press the LIGHT button to exit.

Temperature | Humidity Trend Arrows

- The temperature and humidity trend arrows update every 15 minutes. The trend reflects changes (2°F and 3% humidity) over the past 1 hour. E.g.: At 1:00 - compare to 12:00 data; at 1:15 compare to 12:15; at 1:30 - compare to 12:30 etc



Up Arrow: Rising



Right Arrow: Steady



Down Arrow: Falling

Weather Forecast Icons

- The forecast icons are determined by the station's barometric pressure reading.
- When Outdoor temperature is below 32°F and the forecast is RAIN or T-STORM, the station will display SNOW.

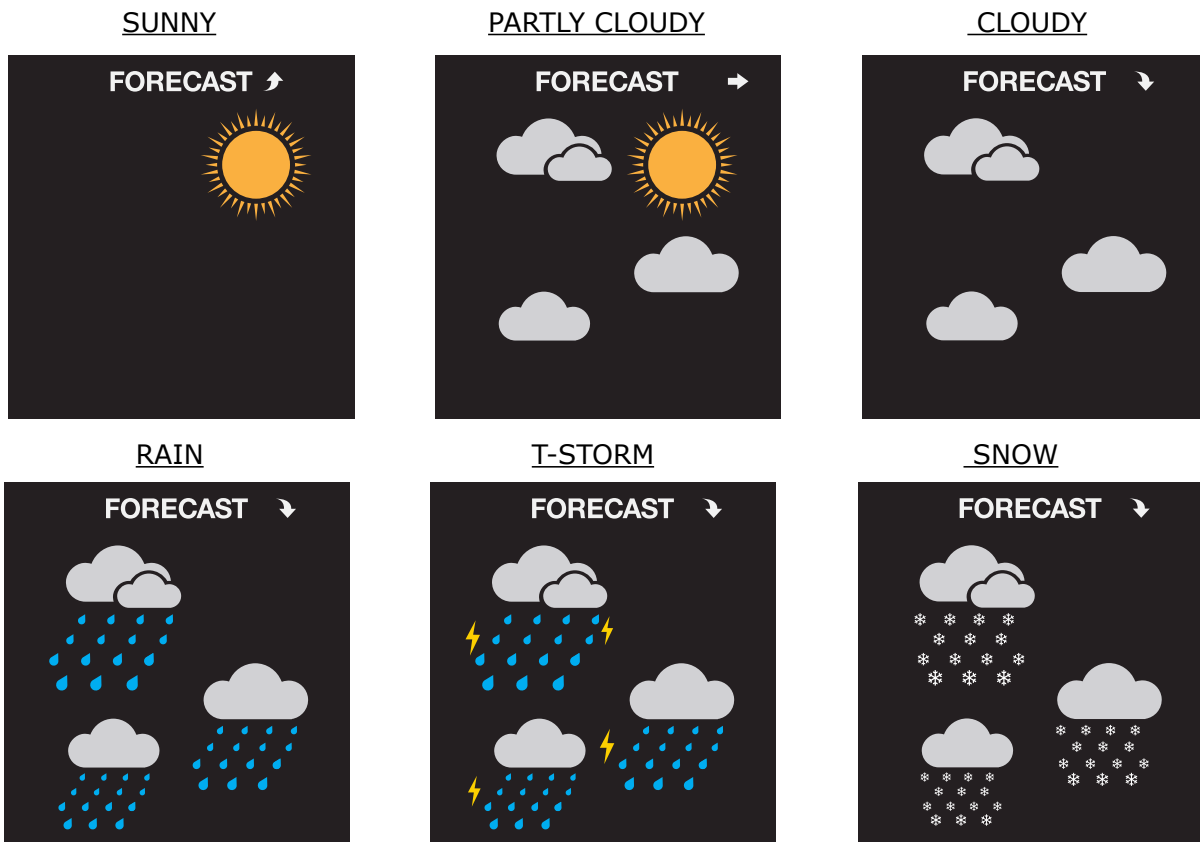

Forecast Trend Arrows

Forecast trend arrows indicate the rise and fall of barometric pressure.



Up Arrow: Rising
Weather will improve



Right Arrow: Steady
No change



Down Arrow: Falling
Weather will worsen

Backlight Adjustments

Use the power cord for constant backlight:

- Press the LIGHT button on the top of the weather station to adjust the backlight (HI-LOW-OFF) when using the power cord.

When using battery power only:

- Press the LIGHT button for a 10 second backlight.

Change Batteries

TX144W Sensor:

1. Grab the vented portion of the sensor and turn counter clockwise.
2. Remove old batteries and install fresh "C" batteries.
3. Carefully align and turn vented portion clockwise to tighten.
4. Hold the WIND button on the weather station for 3 seconds to search for the sensor.

TX144W Sensor

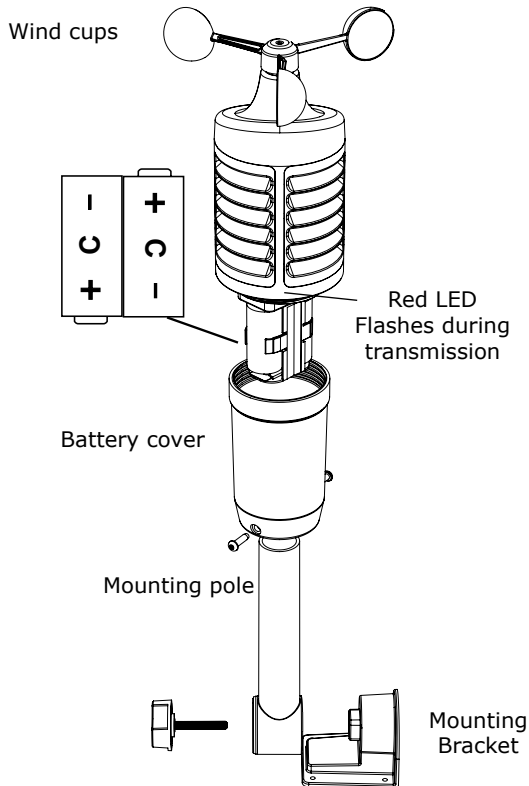

TX141TH-BCH Sensor

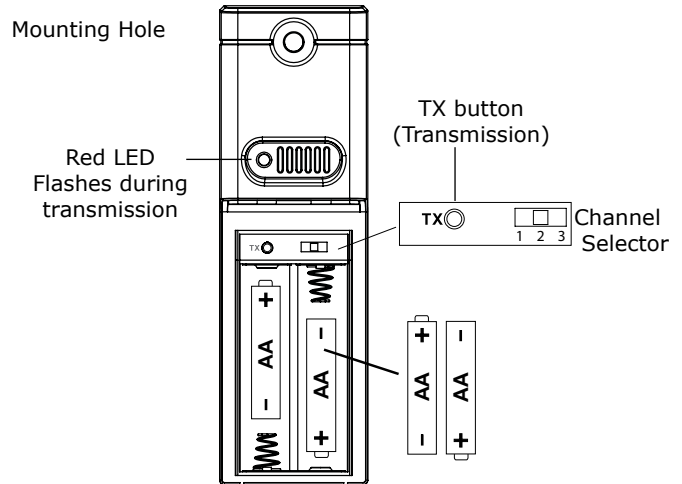

TX141TH-BCH Sensor(s):

1. Slide battery cover down and lift off sensor.
2. Remove old batteries and install fresh "AA" batteries.
3. Hold the TEMP button on the weather station for 3 seconds to search for the sensor.

Sensor Search

- Hold the WIND button for 3 seconds to search for the wind sensor.
- Hold the TEMP button for 3 seconds to search for all temp/humidity sensors.
- If the signal is lost, the unit will display the last data recorded for 30 minutes. If the signal is still not received after this time, dashes will be displayed on screen.
- After 60 minutes, the station will begin to search for the missing signal automatically.
- The signal strength indicators will flash while searching and be solid when connected.



Connect Add-on Sensors to Station

- The wind station will accommodate up to two additional (TX141TH-BCHv3)* Thermo-Hygro sensors on channels 2 & 3.

*Additional sensors sold separately & can be purchased here:

www.lacrossetechnology.com/tx141th-bch-temperature-humidity-sensor

Note: No additional TX144W wind speed sensors may be added.

Connect add-on sensor(s) to the wind station:

1. Remove the battery cover from all add-on sensors (leave off).
2. Set the first additional sensor to Channel 2 and insert 2 "AA" batteries.
3. Set the second additional sensor to Channel 3 and insert 2 ""AA"" batteries.
4. Hold the TEMP button on the station for 3 seconds to search for sensors.
5. Press the TX button on each sensor.
6. When connection is established, the temperature and humidity for each of the selected channels will appear.
7. Install the battery covers on each sensor.
8. Keep sensors and the wind station 5-10 feet apart for 15 minutes for a solid connection.
9. After 15 minutes, place the remote sensors in appropriate shaded locations.
10. Press and release the -/CH button to view channels 1,2 or 3 on the wind station.

Note: CH 1 will show consistently. CH 2 and CH 3 will only show if sensors are connected to the station on those channels.

View Channels (when add-on sensors in use)

- Press the -/CH button to toggle between remote sensor channels when multiple sensors are used.
- Channels are indicated with CH 1, CH 2 or CH 3, in the outdoor temperature area.

Note: When using multiple TH sensors, select the channel by pressing the -/CH button prior to viewing HI | LO readings or setting temperature/humidity Alerts

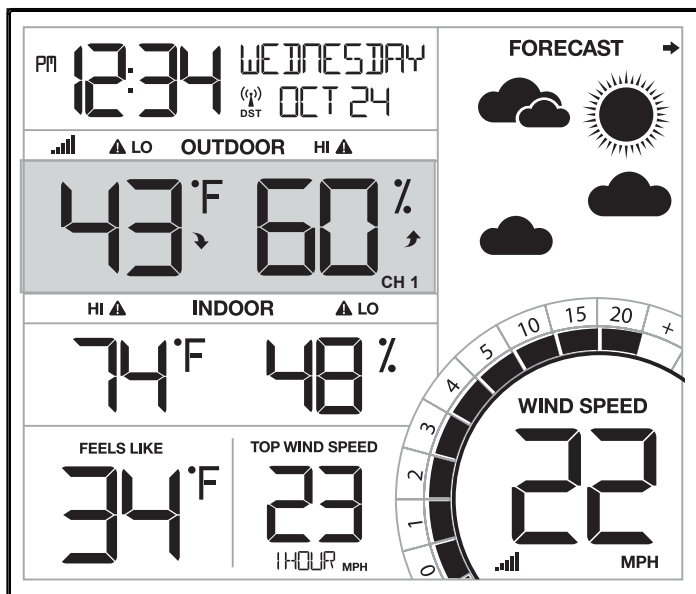

Mounting TX141TH-BCHv3 Sensor

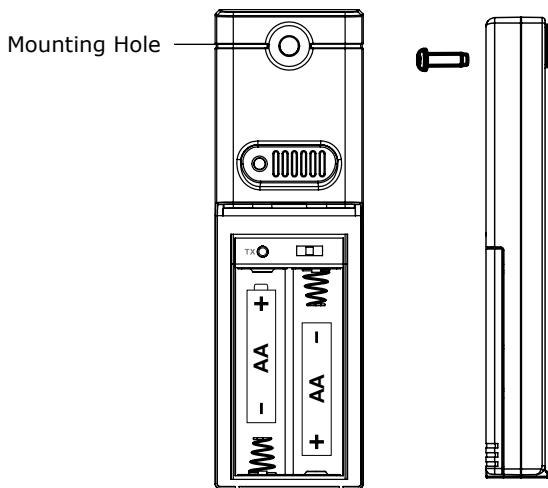

- To mount the sensor, use the hole at the top to either hang it from the back using a nail, or inserts one mounting screw through the front
- Mount the TX141TH-BCHv3 sensor on a north-facing wall or in any shaded area. Under an eave or deck rail is preferred.
- The maximum wireless transmission range to the weather station is over 330 feet (100 meters) in open air, not including walls or floors.
- Be sure the sensor is mounted vertically, to allow moisture to drain out properly.
- http://bit.ly/TH_SensorMounting

Mounting TX144W Sensor

- For the most accurate wind speed readings, mount the TX144W sensor as the highest object for 50 feet in all directions.
- Mount sensor vertically with the wind cups on top.
- The maximum wireless transmission range to the wind station is over 330 feet (100 meters) in open air, not including walls or trees.

1. Insert mounting pole into sensor.
2. Tighten screws
3. Insert bottom of pole into mounting bracket
4. Tighten knob to secure
5. Use screws through the bottom of the mounting bracket to attach.
6. The sensor can be mounted from the bottom or side.

Alternatively:

1. Insert your own mounting pole into the sensor.
2. Tighten screws
3. Mounting bracket would not be used.

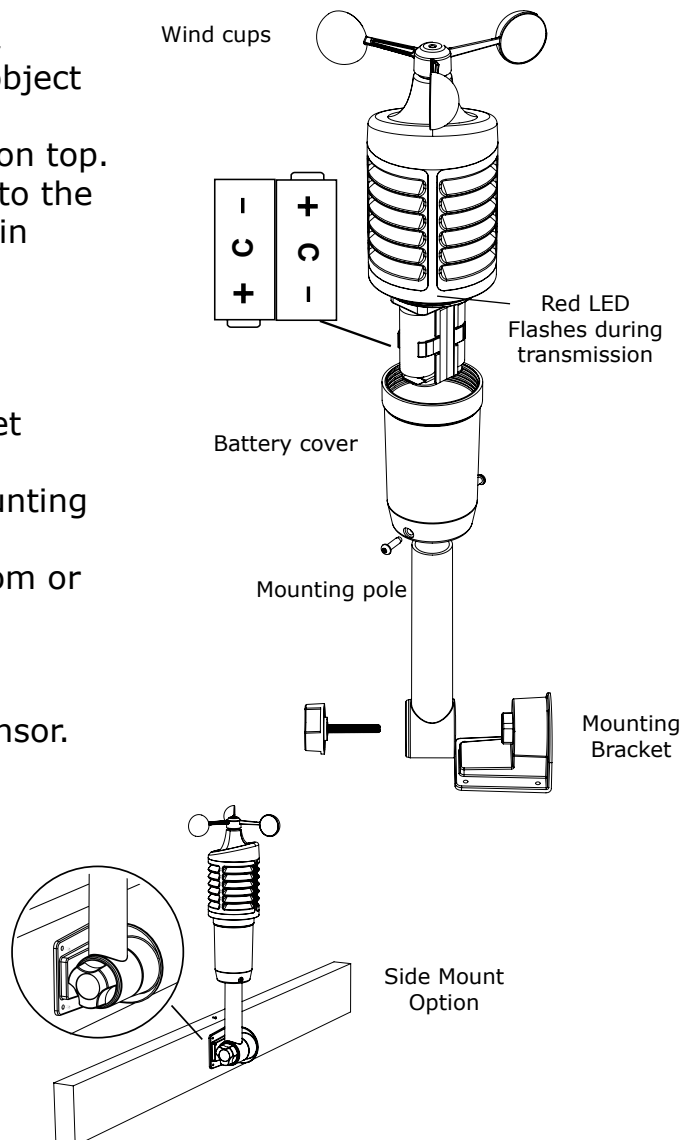

Position Weather Station

- Pull out the stand and place on a flat surface.
 - Or use the two hanging holes on the back to mount on the wall, near an outlet for constant backlight.
1. Choose a location 6 feet or more away from electronics such as cordless phones, gaming systems, televisions, microwaves, routers, etc.
 2. Place within range of the outdoor sensors (330 ft, 100m open air).
 3. Obstacles such as walls, windows, stucco, concrete, and large metal objects can reduce the range.
 4. For best WWVB reception, orientate the weather station with the front or back of the station facing Ft. Collins, Colorado.

Replace Wind Cups

1. Loosen the screw
2. Remove cups
3. Install new cups
4. Tighten screw

Note: The screw in the wind cups will fit snugly on the flat side of the metal stem on the wind sensor.

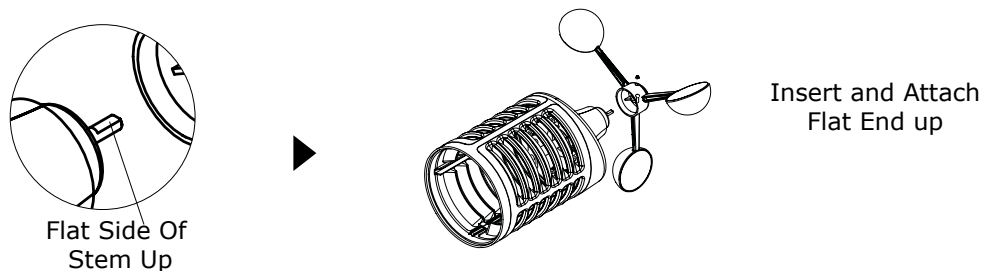

Factory Reset/Clear Memory

1. Hold down both the LIGHT and ALERTS button together for 5 second. This will clear all recorded weather data and reset the station's settings back to default
2. The weather station will fully populate, clear all records, then return to a normal display and search for outdoor sensors.
3. While searching for the outdoor sensors the Wind Speed, and Outdoor Temperature/Humidity will show dashes.
4. Once connected to the outdoor sensors (allow 3 minutes) the Wind Speed, and Temperature/Humidity will show current readings.
5. In the absence of wind this reading will show 0.00.

Dashes = Not connected to sensor

0 or current readings = Connected to sensor.

Visit Us on Social Media



Latest video content

http://bit.ly/LaxTech_YouTube



For personalized interaction

http://bit.ly/LaxTech_Facebook



Join the conversation

http://bit.ly/LaxTech_Twitter



Pin and share

http://bit.ly/LaxTech_Pinterest

Care and Maintenance

- Do not mix old and new batteries
- Do not mix Alkaline, Standard, Lithium or Rechargeable Batteries
- Always purchase the correct size and grade of battery most suitable for intended use.
- Replace all batteries of a set at the same time
- Promptly remove expired batteries.

Specifications

Indoor

Temperature Range	32°F to 122°F (0°C to 50°C)
Humidity Range	10% to 99% RH
Update Interval	About every 60 seconds

Thermo-hygro Sensor

Temperature Range	-40°F to 140°F (-40°C to 60°C)
Humidity Range	10% to 99% RH
Update Interval	About every 58 seconds
Transmission Range	330 feet (100 meters) RF 433MHz

Wind Speed Sensor

Wind Speed Range	0-111.8 mph (0-180 kmh)
Update Interval	About every 30 seconds
Transmission Range	330 feet (100 meters) RF 433MHz

Power

Weather Station	5.0 Volt 150mA adapter included (Primary) AC6: GPU280500150WAOO Optional: 3-AA, IEC, LR6 batteries (not included)
TX144W Wind sensor	2-C, IEC, LR14 batteries (not included)
TX141TH-BCHv3 sensor	2-AA, IEC, LR6 batteries (not included)

Battery Life

Weather Station	over 12 months when using adapter
TX144W Wind sensor	over 24 months with reputable batteries
TX141TH-BCHv3 sensor	over 24 months with reputable batteries

Dimensions

Weather Station	6.37" H x 6.88" W x 1.33" D in (16.18 cm H x 17.48 cm W x 3.38 cm D)
TX144W Wind sensor	11.94" H x 6.24" W x 5.63" D (30.33 cm H x 15.85 cm W x 14.30 cm D)
TX141TH-BCHv3 sensor	5.12" H x 1.57" W x 0.79" D (13 cm H x 4.0 cm W x 2.0 cm D)

Warranty and Support

La Crosse Technology, Ltd. provides a 1-year limited time warranty (from date of purchase) on this product relating to manufacturing defects in materials & workmanship.

Before returning a product, please contact our friendly customer support or visit our online help:

Phone: 1-608-782-1610

Online: www.lacrosstechnology.com/support/

View full warranty details online at:

www.lacrosstechnology.com/warranty_info.pdf

FCC Statement

This equipment has been tested and found to comply with the limits for a Class B digital device, pursuant to part 15 of the FCC Rules. These limits are designed to provide reasonable protection against harmful interference in a residential installation. This equipment generates, uses and can radiate radio frequency energy and, if not installed and used in accordance with the instructions, may cause harmful interference to radio communications. However, there is no guarantee that interference will not occur in a particular installation.

If this equipment does cause harmful interference to radio or television reception, which can be determined by turning the equipment off and on, the user is encouraged to try to correct the interference by one or more of the following measures:

- Reorient or relocate the receiving antenna.
- Increase the separation between the equipment and receiver.
- Connect the equipment into an outlet on a circuit different from that to which the receiver is connected.
- Consult the dealer or an experienced radio/TV technician for help.

This device must not be co-located or operating in conjunction with any other antenna or transmitter.

Operation is subject to the following two conditions:

- (1) This device may not cause harmful interference, and
- (2) This device must accept any interference received, including interference that may cause undesired operation.

Caution!

The manufacturer is not responsible for any radio or TV interference caused by unauthorized changes or modifications to this equipment. Such changes or modifications could void the user authority to operate the equipment.

This equipment must be installed and operated in accordance with provided instructions and the antenna(s) used for this transmitter must be installed to provide a separation distance of at least 20 cm from all persons and must not be co-located or operating in conjunction with any other antenna or transmitter

All rights reserved. This manual may not be reproduced in any form, even in part, or duplicated or processed using electronic, mechanical or chemical process without the written permission of the publisher. This booklet may contain errors or misprints. The information it contains is regularly checked and corrections are included in subsequent editions. We disclaim any responsibility for any technical error or printing error, or their consequences.

All trademarks and patents are recognized.

Canada Statement

This device complies with Industry Canada's licence-exempt RSSs

Operation is subject to the following two conditions:

- (1) This device may not cause interference; and
- (2) This device must accept any interference, including interference that may cause undesired operation of the device.

The device meets the exemption from the routine evaluation limits in section 2.5 of RSS 102 and compliance with RSS-102 RF exposure, users can obtain Canadian information on RF exposure and compliance.

This transmitter must not be co-located or operating in conjunction with any other antenna or transmitter. This equipment should be installed and operated with a minimum distance of 20 centimeters between the radiator and your body.